

# Service Information

## Changes for the 6kW Igniter

The 6kW Igniter was changed from pinned contacts to screwed contacts.

The Production with the new igniters began with the following serial numbers:

- » **Compact 6kW** (from serial number 1482)
- » **ARRI X 60** (from serial number 225)
- » **ARRISUN 60** (from serial number 2744)

ID-Nr.	Description	Lamphead
L4.77543.E	<del>Igniter with pinned contacts</del>	» <del>ARRISUN 60</del> » <del>Compact 60</del> » <del>ARRI X 60</del>
Contains:	» Igniter 6kW OLD » Insulation bushing (2x)  <b>Is not available anymore!</b>	

The following is a list of spare parts for repairs related to this claim:

ID-Nr.	Description	Lamphead
L4.90312.E	Igniter 6kW incl. HT-cables	» Compact 6kW (from serial number 1482)
Contains:	» HT-cable long (1x) » HT-cable short (1x) » Igniter 6kW NEW (1x) » Cylinder head screw (2x) » Spring washer (2x)	 <b>Old HT-cables will not fit!</b>

ID-Nr.	Description	Lamphead
L4.90340.E	Igniter 6kW only	<ul style="list-style-type: none"> <li>» Compact 6kW (from serial number 1482)</li> <li>» ARRI X60 (from serial number 225)</li> <li>» AS60 (from serial number 2744)</li> </ul>
Contains:	<ul style="list-style-type: none"> <li>» Igniter 6kW NEW (1x)</li> </ul> <p><b>Note:</b> Please look carefully at the serial number and hardware status of your Lamphead before ordering.</p>	 <p style="color: red; text-align: center;">Old HT-cables will not fit!</p>

ID-Nr.	Description	Lamphead
L4.90341.E	HT-cables long/short	<ul style="list-style-type: none"> <li>» Compact 6kW (from serial number 1482)</li> </ul>
Contains:	<ul style="list-style-type: none"> <li>» HT-cable long (1x)</li> <li>» HT-cable short (1x)</li> <li>» Cylinder head screw (2x)</li> <li>» Spring washer (2x)</li> </ul>	

ID-Nr.	Description	Lamphead
L4.90344.E	Cable sleeves for Compact 6kW	» Compact 6kW (Please do NOT use these parts for the Compact 6000 Plus!)
Contains:	<b>Note:</b> Sleeves insulate the HT-cables and must always be installed before using the lamphead in order to prevent short circuiting and damage to HT cables and igniter. The sleeves must be undamaged before installing.	

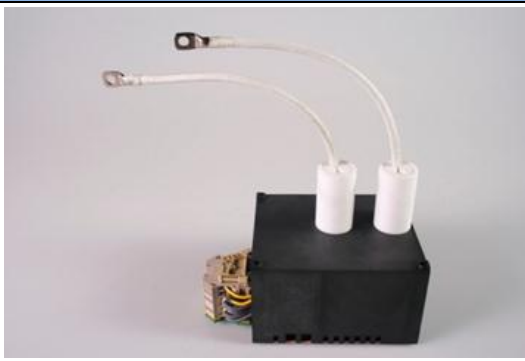
ID-Nr.	Description	Lamphead
L4.90313.E	Igniter 6kW incl. HT-cables	» ARRI X60 (from serial number 225)
Contains:	<ul style="list-style-type: none"> <li>» HT-cable short (2x)</li> <li>» Cylinder head screw (2x)</li> <li>» Spring washer (2x)</li> <li>» Sleeve 10cm</li> <li>» Insulation bushing (2x)</li> </ul>	 <p style="color: red;">Old HT-cables will not fit!</p>

ID-Nr.	Description	Lamphead
L4.90339.E	HT-cables short	» ARRI X60 (from serial number 225)
Contains:	<ul style="list-style-type: none"> <li>» HT-cable short (2x)</li> <li>» Cylinder head screw (2x)</li> <li>» Spring washer (2x)</li> </ul>	

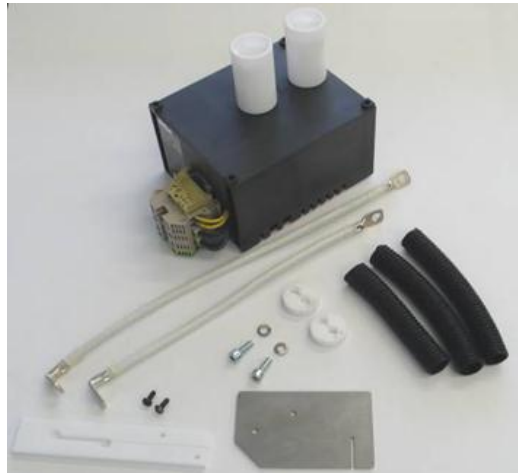
ID-Nr.	Description	Lamphead
L4.90780.E	Igniter 6kW incl. HT-cables	» ARRISUN 60 (from serial number 2744)
Contains:	<ul style="list-style-type: none"> <li>» Igniter 6kW NEW (1x)</li> <li>» HT-cable long (1x)</li> <li>» HT-cable short (1x)</li> <li>» Teflonholder to be fixed (1x)</li> <li>» Drilling template (1x)</li> <li>» Cylinder head screw (2x)</li> <li>» Spring washer (2x)</li> <li>» Sleeve (3x)</li> <li>» Screws (2x)</li> <li>» Insulation bushing (2x)</li> <li>» Nuts (2x)</li> </ul> <p><b>Note:</b> Use this retrofit kit to update all models from serial number 1 to 2744.</p> <p>For newer models (from serial number 2744 and greater) with damaged HT cables and/or damaged igniter please order  L4.90340.E- Igniter  L4.90343.E- HT Cables</p>	 <p style="color: red; text-align: center;">Old HT-cables will not fit!</p>

ID-Nr.	Description	Lamphead
L4.90781.E	HT-cables long/short with sleeve and teflonholder	» ARRISUN 60 (from serial number 2744)
Contains:	<ul style="list-style-type: none"> <li>» HT-cable long (1x)</li> <li>» HT-cable short (1x)</li> <li>» Teflonholder to be fixed (1x)</li> <li>» Drilling template (1x)</li> <li>» Cylinder head screw (2x)</li> <li>» Spring washer (2x)</li> <li>» Sleeve (3x)</li> <li>» Screws (2x)</li> <li>» Nuts (2x)</li> </ul> <p><b>Note:</b> If the igniter is NOT damaged, however the HT-cables, sleeves and teflonholder are damaged order this set if the serial number is greater than 2744 or your lamphead is updated.</p>	



ID-Nr.	Description	Lamphead
L4.90343.E	HT-cables long/short with sleeve	» ARRISUN 60 (from serial number 2744)
Contains:	<ul style="list-style-type: none"> <li>» HT-cable long (1x)</li> <li>» HT-cable short (1x)</li> <li>» Cylinder head screw (2x)</li> <li>» Spring washer (2x)</li> <li>» Sleeve (3x)</li> </ul> <p><b>Note:</b> If only the HT-cables and sleeves are damaged, please order this set if the serial number is greater than 2744 or your lamphead is updated.</p>	

ID-Nr.	Description	Lamphead
L4.90782.E	Teflonholder set	» ARRISUN 60 (from serial number 2744)
Contains:	<ul style="list-style-type: none"> <li>» Teflonholder to be fixed (1x)</li> <li>» Drilling template (1x)</li> <li>» Screws (2x)</li> <li>» Nuts (2x)</li> </ul>	

ID-Nr.	Description	Lamphead
L2.77480.E	ARRISUN 60 retrofit kit	» ARRISUN 60 (from serial number 2744)
Contains:	<ul style="list-style-type: none"> <li>» Teflonholder to be fixed (1x)</li> <li>» Drilling template (1x)</li> <li>» Screws (2x)</li> <li>» Nuts (2x)</li> <li>» Sleeve (3x)</li> </ul> <p><b>Is not available anymore!</b></p>	

### Additional Information:

If your igniter cables are from older versions, they look like the following:

AS60 - older versions		
ID-Nr.	Description	
L4.77565.E	HT-cables cpl. Thread: 17mm to serial number 1609  <b>Note:</b> For damaged igniter, please use retrofit set: L4.90780.E. If only the HT cables are damaged and need to be replaced the original HT cable part number can be ordered.	
L4.72586.E	HT-cables cpl. Thread: 20 mm from serial number 1609  <b>Note:</b> For damaged igniter, please use retrofit set: L4.90780.E. If only the HT cables are damaged and need to be replaced the original HT cable part number can be ordered.	

Compact 6kW - older versions		
ID-Nr.	Description	
L4.75937.E	Thread: 17 mm HT-cables complete to serial number 723	
L4.76251.E	Thread: 20 mm HT-cables complete from serial number 724	

ARRI X 6kW - older versions		
ID-Nr.	Description	
L4.82743.E	Thread 17 mm HT-cables complete to serial number 170	
L4.82947.E	Thread 20 mm HT-cables complete from serial number 171	