

# P 18 WASH MK2

DMX Protokoll | DMX Chart

Version 1.01

Software >= 1.1.0

## Inhalt / Content

Deutsch

<b>1.0 P18 Wash MK2 Modelle</b> .....	<b>03</b>
<b>2.0 Menü-Übersicht</b> .....	<b>04</b>
<b>3.0 Kanalbelegung</b> .....	<b>06</b>
3.1 DMX .....	06
3.1.1 Übersicht DMX-Kanäle .....	06
3.1.2 DMX-Kanalbelegung Mode 1 und Mode 2 .....	08
3.1.3 Steuerkanal .....	14
3.1.4 Sparkle Effekt, Sparklegeschwindigkeit .....	14
3.1.5 Zoom, Autofokus Distanz, Autofokus Abgleich .....	14
3.2 Artnet .....	14
3.3 Streaming ACN .....	14
3.4 Wireless-DMX .....	14
3.5 RDM .....	15
3.5.1 RDM-UID .....	15
3.5.2 RDM-PIDs .....	15
3.5.3 Standard RDM-Parameter-IDs .....	15
3.5.4 Herstellerspezifische RDM-Parameter-IDs .....	16
3.5.5 RDM-Sensoren-IDs .....	16
<b>4.0 P18 Wash MK2 models</b> .....	<b>19</b>
<b>5.0 Menu overview</b> .....	<b>20</b>
<b>6.0 Control options</b> .....	<b>22</b>
6.1 DMX .....	22
6.1.1 Operating modes .....	22
6.1.2 DMX channel assignment Mode 1 and Mode 2 .....	24
6.1.3 Control channel .....	30
6.1.4 Sparkle effect, sparkle speed .....	30
6.1.5 Zoom, auto focus distance, autofocus adjust .....	30
6.2 Artnet .....	30
6.3 Streaming ACN .....	30
6.4 Wireless-DMX .....	30
6.5 RDM .....	31
6.5.1 RDM-UID .....	31
6.5.2 RDM-PIDs .....	31
6.5.3 Standard RDM parameter IDs .....	31
6.5.4 Manufacturer specific RDM parameter IDs .....	32
6.5.5 RDM sensor IDs .....	32

English

## 1.0 P18 Wash MK2 Modelle

Der P18 Wash MK2 ist in 3 Modellen verfügbar. Die Modelle unterscheiden sich im Lichtmodul und teilweise in den Farbfiltern und in den CTC-Filtern. Die Unterschiede werden jeweils bei den DMX-Kanalfunktionen angegeben.

- **P18 Wash MK2 HP (High Power)**
- **P18 Wash MK2 HC (High CRI)**
- **P18 Wash MK2 WW (Warm weiß)**

# P 18 WASH MK2

## 2.0 Menü-Übersicht

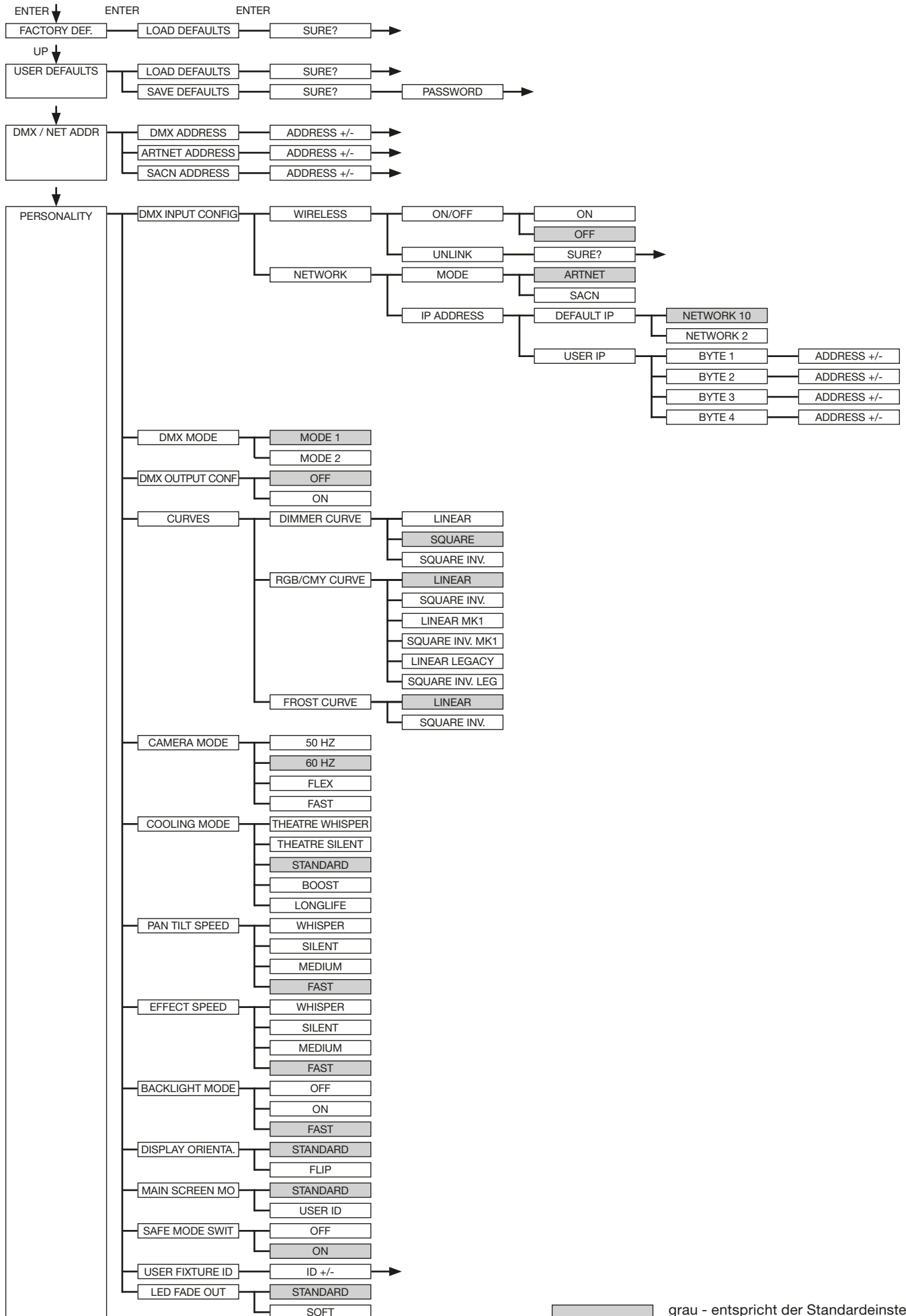

grau - entspricht der Standardeinstellung

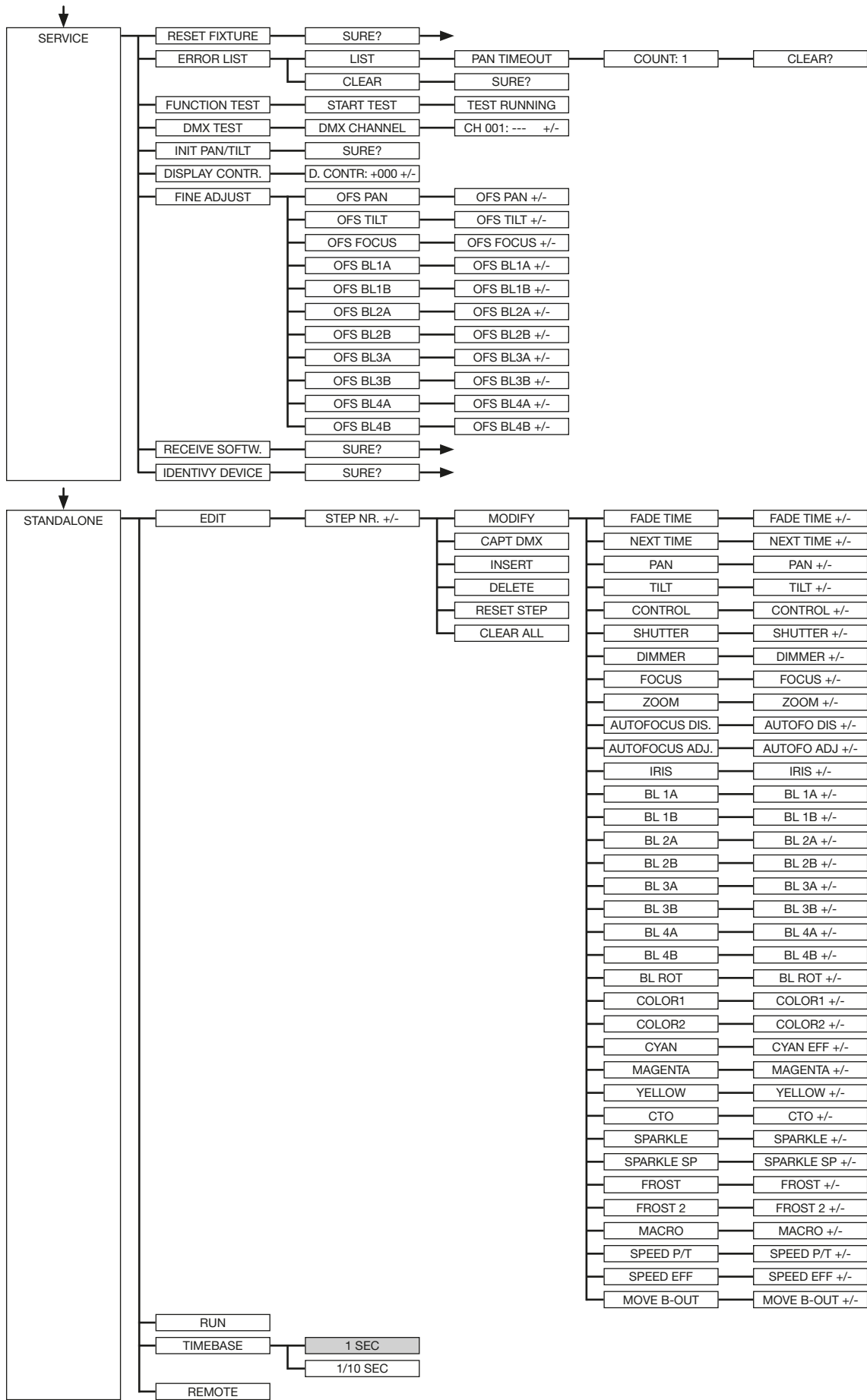

# P 18 WASH MK2

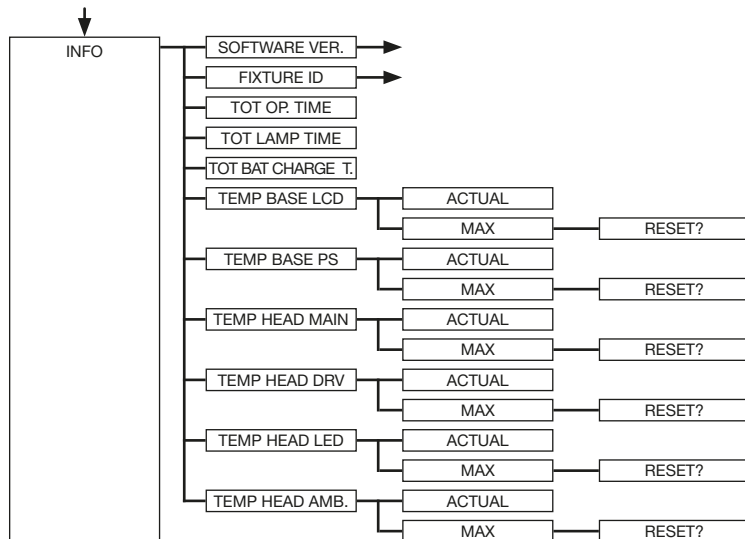

## 3.0 Kanalbelegung

### 3.1 DMX

#### 3.1.1 Übersicht DMX-Kanäle

Der P18 Wash MK2 verfügt über 2 unterschiedliche DMX-Modi. Der jeweilige Modus lässt sich im Menüpunkt PERSONALITY -> DMX MODE einstellen. Der eingestellte Mode wird im Hauptmenü angezeigt.

	Mode 1 (M1)	Mode 2 (M2)
Kanal 1	Pan	Pan
Kanal 2	Pan fein	Pan fein
Kanal 3	Tilt	Tilt
Kanal 4	Tilt fein	Tilt fein
Kanal 5	Steuerkanal	Steuerkanal
Kanal 6	Shutter	Shutter
Kanal 7	Dimmer	Dimmer
Kanal 8	Fokus	Dimmer fein
Kanal 9	Zoom	Fokus
Kanal 10	Fokus Distanz	Fokus fein
Kanal 11	Fokus Abgleich	Zoom
Kanal 12	Iris	Zoom fein
Kanal 13	Blende 1a	Fokus Distanz
Kanal 14	Blende 1b	Fokus Abgleich
Kanal 15	Blende 2a	Iris
Kanal 16	Blende 2b	Iris fein
Kanal 17	Blende 3a	Blende 1a
Kanal 18	Blende 3b	Blende 1a fein
Kanal 19	Blende 4a	Blende 1b
Kanal 20	Blende 4b	Blende 1b fein
Kanal 21	Blende-Rotation	Blende 2a
Kanal 22	Farbrad 1	Blende 2a fein
Kanal 23	Farbrad 2	Blende 2b
Kanal 24	Cyan	Blende 2b fein
Kanal 25	Magenta	Blende 3a
Kanal 26	Yellow	Blende 3a fein
Kanal 27	CTO	Blende 3b
Kanal 28	Sparkle	Blende 3b fein

Kanal 29	Sparkle Geschwindigkeit	Blende 4a
Kanal 30	Frost 1	Blende 4a fein
Kanal 31	Frost 2	Blende 4b
Kanal 32	Pan/Tilt-Geschwindigkeit	Blende 4b fein
Kanal 33	Effekt-Geschwindigkeit	Blende-Rotation
Kanal 34	Blackout Move	Blende-Rotation fein
Kanal 35		Farbrad 1
Kanal 36		Farbrad 2
Kanal 37		Cyan
Kanal 38		Cyan fein
Kanal 39		Magenta
Kanal 40		Magenta fein
Kanal 41		Yellow
Kanal 42		Yellow fein
Kanal 43		CTO
Kanal 44		CTO fein
Kanal 45		Sparkle
Kanal 46		Sparkle Geschwindigkeit
Kanal 47		Frost 1
Kanal 48		Frost 2
Kanal 49		Pan/Tilt-Geschwindigkeit
Kanal 50		Effekt-Geschwindigkeit
Kanal 51		Blackout Move

## 3.1.2 DMX-Kanalbelegung Mode 1 und Mode 2





M1	M2	M3	Funktion	DMX
1	1		<b>Pan (X)</b> Bewegung 546,74°	000-255
2	2		<b>Pan (X)</b> fein (16 Bit)	000-255
3	3		<b>Tilt (Y)</b> Bewegung 281,16°	000-255
4	4		<b>Tilt (Y)</b> fein (16 Bit)	000-255
5	5		<p><b>Steuerkanal</b> Um gleichmäßiges Ausdimmen manuell über Fader für alle Lichtmischpulte zu ermöglichen stehen 5 verschiedene Einstellungen für die DMX-Glättung zur Verfügung. Sollte bei manchen DMX-Pulten das DMX-Signal abreißen oder zu wenige Pakete gesendet werden, kann mit diesem Kanal das Ansprechverhalten des Scheinwerfers angepasst werden. Die Einstellung für minimale DMX-Glättung sollte bei den meisten gängigen Pulten funktionieren. Die Werte für DMX-Glättung müssen Dauerhaft an den Scheinwerfer gesendet werden. Bei den anderen Werten wie z.B. Cooling Mode, Farbtemperatur usw. müssen die Werte für 2 Sekunden anliegen, dann wird das Gerät dauerhaft umgeschaltet. (Wie bei der Umstellung im Menü PERSONALITY)</p> <p><b>Einstellung für minimale DMX-Glättung</b> (Eine gedimmte Shuttersequenz ist möglich) Dimmer Fade out über Fader (schnell - langsam) nicht belegt</p> <p><b>Einstellung für minimale/mittlere DMX-Glättung</b> Dimmer Fade out über Fader (schnell - langsam) nicht belegt</p> <p><b>Einstellung für mittlere DMX-Glättung</b> Dimmer Fade out über Fader (schnell - langsam) nicht belegt</p> <p><b>Einstellung für mittlere/maximale DMX-Glättung</b> Dimmer Fade out über Fader (schnell - langsam)</p> <p><b>BACKLIGHT MODE - Display-Hintergrundbeleuchtung</b> AUTO - der Scheinwerfer steuert die Hintergrundbeleuchtung automatisch ON - die Hintergrundbeleuchtung ist immer an OFF - die Hintergrundbeleuchtung ist immer aus, bis eine Taste gedrückt wird</p> <p><b>DISPLAY ORIENTATION - Displayausrichtung</b> STANDARD - das display ist zu lesen wenn der Scheinwerfer steht FLIP - die Displayausrichtung ist um 180° gedreht, hängend lesbar nicht belegt</p> <p><b>MAIN SCREEN MODE - Ansicht Hauptbildschirm</b> STANDARD - zeigt die DMX-Adresse, -Mode und bei akt. Wireless die Feldstärke USER FIXTURE ID - zeigt die frei definierbare Fixture-ID / Scheinwerfernummer nicht belegt</p> <p><b>USER FIXTURE ID SET - Scheinwerfernummer setzen</b> SET - hiermit kann die USER ID eingestellt werden. der Scheinwerfer übernimmt den 16Bit Wert von Pan für die USER ID nicht belegt</p>	<p>000-007 008-031</p> <p>032-039 040-063</p> <p>064-071 072-095</p> <p>096-103</p> <p>104-104 105-105 106-106</p> <p>107-107 108-108 109-109</p> <p>110-110 111-111 112-112</p> <p>113-113 114-127</p>



	<b>Einstellung für maximale DMX-Glättung</b> Dimmer Fade out über Fader (schnell - langsam)	128-135
	<b>DIMMER CURVE - Einstellung der Dimmerkurve</b> LINEAR - lineare Dimmerkurve SQUARE - exponentielle Dimmerkurve SQUARE INVERS - exponentiell inverse Dimmerkurve nicht belegt	136-136 137-137 138-138 139-139
	<b>RGB/CMY CURVE - Einstellung der RGB/CMY-Kurve</b> LINEAR - lineare RGB/CMY-Kurve SQUARE INVERS - exponentiell inverse RGB/CMY-Kurve LINEAR MK1 - lineare RGB/CMY-Kurve angepasst an P18 MK1	140-140 141-141 142-142
	<b>FROST CURVE - Einstellung der Frostkurve</b> LINEAR - lineare Frostkurve SQUARE INVERS - exponentiell inverse Frostkurve nicht belegt	143-143 144-144 145-145
	<b>PAN/TILT SPEED - Pan/Tilt-Geschwindigkeit</b> WHISPER SILENT MEDIUM FAST	146-146 147-147 148-148 149-149
	<b>EFFECT SPEED - Effekt-Geschwindigkeit</b> WHISPER SILENT MEDIUM FAST	150-150 151-151 152-152 153-153
	<b>LED FADE OUT MODE - Art der Ausdimmung</b> STANDARD SOFT nicht belegt	154-154 155-155 156-159
	<b>COOLING MODE - Einstellung der Lüfterlautstärke und der Helligkeit</b> Die Umschaltung erfolgt mit Dimmer/Shutter zu (DMX 000) dann nach 2 Sekunden außer die Schalter "SAFE MODE SWITCH" im PERSONALITY-Menü sthet auf OFF, dann kann die Umschaltung direkt erfolgen ohne dass Dimmer und Shutter zu sein müssen. THEATRE WHISPER THEATRE SILENT STANDARD BOOST LONGLIFE nicht belegt	160-160 161-161 162-162 163-163 164-164 165-207
	<b>CAMERA MODE - Einstellung der LED-Wiederhofrequenz</b> 50Hz 60Hz FLEX - 600Hz High FLEX - 3kHz nicht belegt	208-215 216-223 224-227 228-231 232-239
	<b>RESET - ein Grundreset des Scheinwerfers wird durchgeführt</b> Reset (nach 2 Sekunden) nicht belegt	240-247 248-255

# P 18 WASH MK2

6	6	<b>Shutter</b> Shutter zu Shutter auf Shutter pulsierend öffnen >20Hz (schnell - langsam) Shutter auf Fade-Effekt mit Dimmer (langsam - schnell) Shutter auf Shutter zu Shutter pulsierend öffnen <20Hz (schnell - langsam) Shutter auf Shutter pulsierend schließen (schnell - langsam) Shutter zu Shutter fade, 0% (schnell - langsam) Shutter auf Shutter fade, 100% (schnell - langsam) Shutter zu Shutter Zufall 100% (schnell - langsam) Shutter auf Shutter Zufall 0% (schnell - langsam) Shutter zu Shutter Zufall fade 0% (schnell - langsam) Shutter auf Shutter Zufall fade 100% (schnell - langsam) Shutter auf	000-015 016-095 096-110 111-111 112-125 126-126 127-126 128-142 143-143 144-158 159-159 160-174 175-175 176-190 191-191 192-206 207-207 208-222 223-223 224-238 239-239 240-254 255-255
7	7	<b>Dimmer 0 - 100%</b>	000-255
	8	<b>Dimmer fein (16Bit)</b>	000-255
8	9	<b>Fokus 0-100%</b>	000-255
	10	<b>Fokus fein (16 Bit)</b>	000-255
9	11	<b>Zoom 0 -100% (nah 13° - weit 65°)</b>	000-255
	12	<b>Zoom fein (16 Bit)</b>	000-255
10	13	<b>Autofokus Distanz (ab Version 1.5)</b> Autofokus aus Autofokus 0 m - 25,5 m (0 = aus, DMX / 10 = Entfernung)	000-001 002-255
11	14	<b>Autofokus Feinabgleich (ohne Funktion, wird nicht benötigt)</b> Autofokus Feinabgleich - 128 Mittelstellung	000-255
12	15	<b>Iris 0-100% (offen -&gt; zu)</b>	000-255
	16	<b>Iris fein (16Bit)</b>	000-255
13	17	<b>Goborad 2 - rotierende Gobos</b> Gobo 0  Gobo 1	 000-007  008-015

		Gobo 2		016-023
		Gobo 3		024-031
		Gobo 4		032-039
		Gobo 5		040-047
		Gobo 6		048-127
		Gobo 0 (open)		128-135
		Gobo 1 Shake (schnell - langsam)		136-143
		Gobo 2 Shake (schnell - langsam)		144-151
		Gobo 3 Shake (schnell - langsam)		152-159
		Gobo 4 Shake (schnell - langsam)		160-167
		Gobo 5 Shake (schnell - langsam)		168-175
		Gobo 6 Shake (schnell - langsam)		176-191
		Goborotation (schnell - langsam)		192-223
		Goborotation (langsam - schnell)		224-255
14	18	<b>Gobopositionierung / -rotation 2</b> Gobopositionierung 0°-540° Goborotation rechts (schnell - langsam) Goborotation Stop Goborotation links (langsam - schnell)		000-191 192-222 223-224 225-255
	19	<b>Gobopositionierung / -rotation 2 fein (16 Bit)</b>		000-255
15	20	<b>Blende 1a 0-100%</b>		000-255
	21	<b>Blende 1a fein (16 Bit)</b>		000-255
16	22	<b>Blende 1b 0-100%</b>		000-255
	23	<b>Blende 1b fein (16 Bit)</b>		000-255
17	24	<b>Blende 2a 0-100%</b>		000-255
	25	<b>Blende 2a fein (16 Bit)</b>		000-255
18	26	<b>Blende 2b 0-100%</b>		000-255
	27	<b>Blende 2b fein (16 Bit)</b>		000-255
19	28	<b>Blende 3a 0-100%</b>		000-255
	29	<b>Blende 3a fein (16 Bit)</b>		000-255

# P 18 WASH MK2

20	30		<b>Blende 3b</b> 0-100%	000-255
	31		<b>Blende 3b fein</b> (16 Bit)	000-255
21	32		<b>Blende 4a</b> 0-100%	000-255
	33		<b>Blende 4a fein</b> (16 Bit)	000-255
22	34		<b>Blende 4b</b> 0-100%	000-255
	35		<b>Blende 4b fein</b> (16 Bit)	000-255
23	36		<b>Blendenschieber-Rotation</b> -45° / +45°	000-255
	37		<b>Blendenschieber-Rotation fein</b> (16 Bit)	000-255
24	38		<b>Farbrad 1</b> Weiss Weiss / Rot Rot Rot / Gelb Gelb Gelb / Magenta Magenta Magenta / Grün Grün Grün / Orange Orange Orange / Dunkelblau Dunkelblau Dunkelblau / HCRI (Pink Modell HC und WW) HCRI (Pink Modell HC und WW) HCRI (Pink Modell HC und WW) / Weiss Farben linear: Weiss - Rot - Gelb - Magenta - Grün - Orange - Dunkelblau - HCRI (Pink Modell HC und WW) - Weiss Farbraddurchlauf rechts (schnell - langsam) Farbraddurchlauf links (langsam - schnell)	000-001 002-003 004-005 006-007 008-009 010-011 012-013 014-015 016-017 018-019 020-021 022-023 024-025 026-027 028-029 030-031 064-191 192-223 224-255
25	39		<b>Farbrad 2</b> Open 2700K 3200K 4200K 7000K 9000K 12000K Dunkelblau	000-001 004-005 008-009 012-013 016-017 020-021 024-025 028-029
26	40		<b>Cyan</b> (8 Bit) 0-100%	000-255
	41		<b>Cyan fein</b> (16 Bit)	000-255
27	42		<b>Magenta</b> (8 Bit) 0-100%	000-255
	43		<b>Magenta fein</b> (16 Bit)	000-255

28	44	<b>Yellow (Gelb)</b> (8 Bit) 0-100%	000-255
	45	<b>Yellow (Gelb) fein</b> (16 Bit)	000-255
29	46	<b>CTO</b> (8 Bit) 0-100% ( <b>CTB</b> (8 Bit) 0-100% bei Modell WW)	000-255
	47	<b>CTO fein</b> (16 Bit) ( <b>CTB fein</b> (16 Bit) bei Modell WW)	000-255
30	48	<b>Sparkle - Glittereffekt</b> Sparkle Effekt inaktiv Sparkle Effekt Intensität (minimum - maximum)	000-000 001-255
31	49	<b>Sparkle Geschwindigkeit</b> Sparkle Effekt gefadet (langsam -> schnell) Sparkle Effekt geschaltet (langsam -> schnell) Wiederholung der Fade- und Schaltblöcke	000-031 032-063 064-255
32	50	<b>Frost 1</b> Frost 0-100%	000-255
33	51	<b>Frost 2</b> Frost 0-100%	000-255
34	52	<b>Pan/Tilt Geschwindigkeit</b> Bewegung in Echtzeit Bewegung zeitverzögert (schnell - langsam)	000-003 004-255
35	53	<b>Effektgeschwindigkeit</b> Effekte in Echtzeit Effekte zeitverzögert (schnell - langsam)	000-003 004-255
36	54	<b>Blackout Move</b> Nicht belegt Blackout bei Pan/Tilt Blackout bei Farbe, CMY, Iris, Frost Blackout bei Farbe, CMY, Iris, Frost, Zoom, Fokus Blackout bei Farbe, CMY, Iris, Frost, Pan/Tilt Blackout bei Farbe, CMY, Iris, Frost, Zoom, Fokus, Pan/Tilt	000-095 096-127 128-159 160-191 192-223 224-255

### 3.1.3 Steuerkanal

Über den Steuerkanal können verschieden Funktionen des Scheinwerfers permanent umgeschaltet werden. Folgende Funktionen können über den Steuerkanal umgeschaltet werden.

Ansprechverhalten des Scheinwerfers beim Ausdimmen über Fader

BACKLIGHT MODE - Display Hintergrundbeleuchtung

DISPLAY ORIENTATION - Displayausrichtung

MAIN SCREEN MODE - Ansicht Hauptbildschirm

USER FIXTURE ID SET - Scheinwerfernummer setzen

DIMMER CURVE - Einstellung der Dimmerkurve

RGB/CMY CURVE - Einstellung der RGB/CMY-Kurve

FROST CURVE - Einstellung der Frostkurve

PAN/TILT SPEED - Pan/Tilt-Geschwindigkeit

EFFECT SPEED - Effekt-Geschwindigkeit

LED FADE OUT MODE - Art der Ausdimmung

COOLING MODE - Einstellung der Lüfterlautstärke und der Helligkeit

CAMERA MODE - Einstellung der LED-Wiederholfrequenz

RESET - Ein Grundreset des Scheinwerfers wird durchgeführt

Die Details hierzu siehe DMX-Kanalfunktionen für den P18 Wash MK2 auf der Seite 08

### 3.1.4 Sparkle Effekt, Sparklegeschwindigkeit

Über diesen Kanal können in Verbindung mit dem Fokus Animationseffekte erzeugt werden. Je nach Intensität wird die Abbildung mehr oder weniger zum pulsieren angeregt. Dieser Effekt kann gefadet oder geschaltet werden.

### 3.1.5 Zoom, Autofokus Distanz, Autofokus Abgleich

Mithilfe der beiden Kanäle Autofokus Distanz und Autofokus Abgleich kann ab Software Ver. 1.5 der Fokus über den ganzen Zoombereich automatisch nachgeregelt werden

## 3.2 Artnet

Der Scheinwerfer kann über Artnet - ArtNET 4 angesteuert werden. Hierzu über den Menüpunkt DMX / NET ADDR -> ARTNET ADDRESS die Artnetadresse einstellen und zusätzlich über den Menüpunkt PERSONALITY -> DMX INPUT CONFIG -> NETWORK -> MODE -> ARTNET auswählen. Zusätzlich noch die IP-Adresse des Scheinwerfers über PERSONALITY -> DMX INPUT CONFIG -> NETWORK -> IP ADDRESS definieren.

## 3.3 Streaming ACN

Der Scheinwerfer kann über sACN - Streaming ACN angesteuert werden. Hierzu über den Menüpunkt DMX / NET ADDR -> SACN ADDRESS die sACN-Adresse einstellen und zusätzlich über den Menüpunkt PERSONALITY -> DMX INPUT CONFIG -> NETWORK -> MODE -> SACN auswählen. Zusätzlich noch die IP-Adresse des Scheinwerfers über PERSONALITY -> DMX INPUT CONFIG -> NETWORK -> IP ADDRESS definieren.

## 3.4 Wireless-DMX

Der P18 MK2 Wash ist mit einem Lumen-Radio CRMX-Empfänger für Wireless DMX ausgestattet. Der Empfänger kann sowohl DMX als auch RDM verarbeiten. Sollte eine Kabel und Wirelessverbindung am P18 MK2 Wash anliegen hat die Kabelverbindung Vorrang! Das empfangene Signal kann über den DMX-Anschluß ausgegeben werden. Hierzu im Menü PERSONALITY die Einstellung DMX OUTPUT CONFIG auf ON stellen, nach Bestätigung mit ENTER gibt der Scheinwerfer das komplette über Wireless-DMX empfangene Universum aus.

## 3.5 RDM

Der P18 kann über RDM (Remote Device Management) gemäß ESTA American National Standard E1.20-2006 kommunizieren. RDM ist ein bidirektionales Kommunikationsprotokoll für den Einsatz in DMX512-Steuerungssystemen. Es ist der offene Standard für die Konfiguration und Statusüberwachung von DMX-512-Geräten. Das RDM-Protokoll ermöglicht das Einfügen von Datenpaketen in einen DMX-512-Datenstrom, ohne dass bestehende Nicht-RDM-Geräte beeinträchtigt werden. Es ermöglicht einer Konsole oder einem dedizierten RDM-Controller, Befehle an bestimmte Geräte zu senden und Nachrichten zu empfangen. Der P18 kann RDM über Artnet 4 und DMX senden und empfangen. Ebenfalls ist der Scheinwerfer dafür ausgelegt RDM über sACN zu senden und über Artnet zu empfangen. Die RDM-Funktionalität ist abhängig vom eingesetzten Lichtsteuerpult, hierzu muss ebenfalls die Bedienungsanleitung des jeweiligen Pultherstellers beachtet werden.

### 3.5.1 RDM-UID

Jeder P18 hat eine werksseitig festgelegte RDM-UID (eindeutige Identifikationsnummer), die ihn in RDM-Systemen adressierbar und identifizierbar macht.

### 3.5.2 RDM-PIDs

Der P18 unterstützt die gemäß ESTA erforderlichen RDM-PIDs (Parameter-IDs) sowie hersteller-spezifische PIDs.

#### 3.5.3 Standard RDM-Parameter-IDs

RDM-Parameter-ID	GET Befehl	SET Befehl	DISCOVERY	Anmerkungen
<b>RDM-Identifikation</b>				
DISC_UNIQUE_BRANCH			✓	dient der Scheinwerferidentifikation
DISC_MUTE			✓	dient der Scheinwerferidentifikation
DISC_UN_MUTE			✓	dient der Scheinwerferidentifikation
<b>RDM-Statusermittlung</b>				
QUEUED_MESSAGE	✓			
STATUS_MESSAGES	✓			
STATUS_ID_DESCRIPTION	✓			
CLEAR_STATUS_ID		✓		
<b>RDM-Information</b>				
SUPPORTED_PARAMETERS	✓			
<b>RDM-Konfiguration</b>				
DEVICE_MODEL_DESCRIPTION	✓			
MANUFACTURER_LABEL	✓			
FACTORY_DEFAULTS		✓		
SOFTWARE_VERSION_LABEL	✓			
DMX_PERSONALITY		✓		
DMX_PERSONALITY_DESCRIPTION	✓			
DMX_START_ADDRESS		✓		
SENSOR_DEFINITION	✓			
DEVICE_HOURS	✓			
LAMP_HOURS	✓			
IDENTIFY_DEVICE		✓		
RESET_DEVICE		✓		
PERFORM_SELFTEST		✓		
SELFTEST_DESCRIPTION	✓			

## 3.5.4 Herstellerspezifische RDM-Parameter-IDs

RDM-Parameter-ID	GET Befehl	SET Befehl	DISCO-VERY	Anmerkungen
RDM-Konfiguration				
Battery Charge Hours	✓			
Error Number	✓			
Error	✓			
Select Next Error		✓		
Remove Error		✓		
Remove New Error Flag		✓		
User Defaults		✓		
User Fixture ID		✓		
Fixture Lock On/Off	✓	✓		
Dimmer Curve	✓	✓		
RGB Curve	✓	✓		
Frost Curve	✓	✓		
Camera Mode	✓	✓		
Cooling Mode	✓	✓		
Pan Tilt Speed	✓	✓		
Effect Speed	✓	✓		
Backlight Mode	✓	✓		
Disp Orientation	✓	✓		
Main Screen Mode	✓	✓		
Safe Mode Switch	✓	✓		
LED Fade Out Mode	✓	✓		

## 3.5.5 RDM-Sensoren-IDs

RDM-Sensor-ID	GET Befehl	SET Befehl	DISCO-VERY	Anmerkungen
RDM-Sensoren				
Temp Sens Base LCD	✓	✓		
Temp Sens Base PS	✓	✓		
Temp Sens Head PCB	✓	✓		
Temp Sens Head Drv	✓	✓		
Temp Sens Head LED	✓	✓		
Temp Sens Head Air	✓	✓		





English

## 4.0 P18 Wash MK2 models

The P18 Wash MK2 is available in 3 models. The models differ in the light module and partly in the color filters and in the CTC filters. The differences can be found in the DMX channel functions.

- **P18 Wash MK2 HP (High Power)**
- **P18 Wash MK2 HC (High CRI)**
- **P18 Wash MK2 WW (Warm white)**

# P 18 WASH MK2

## 5.0 Menu overview

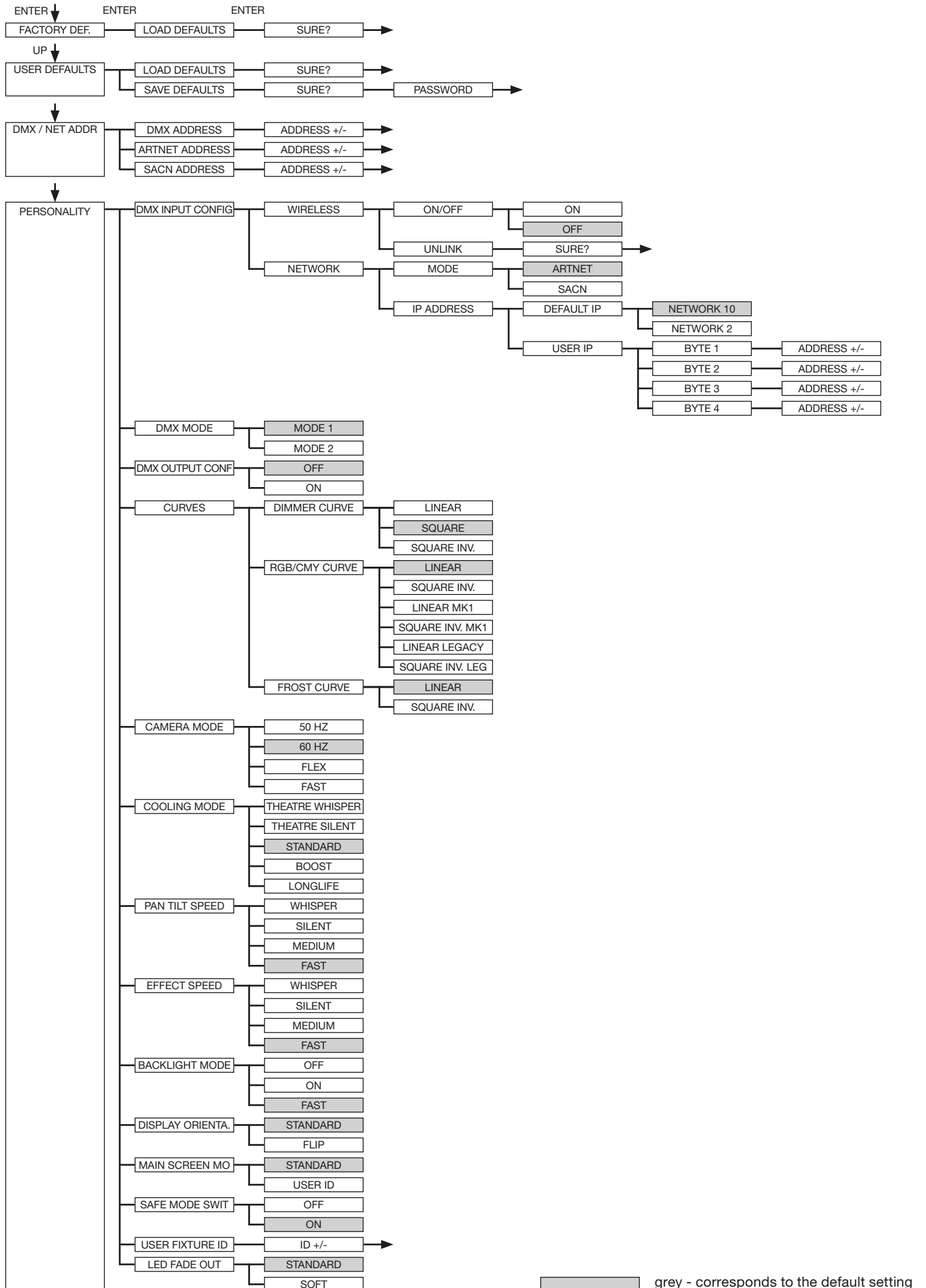

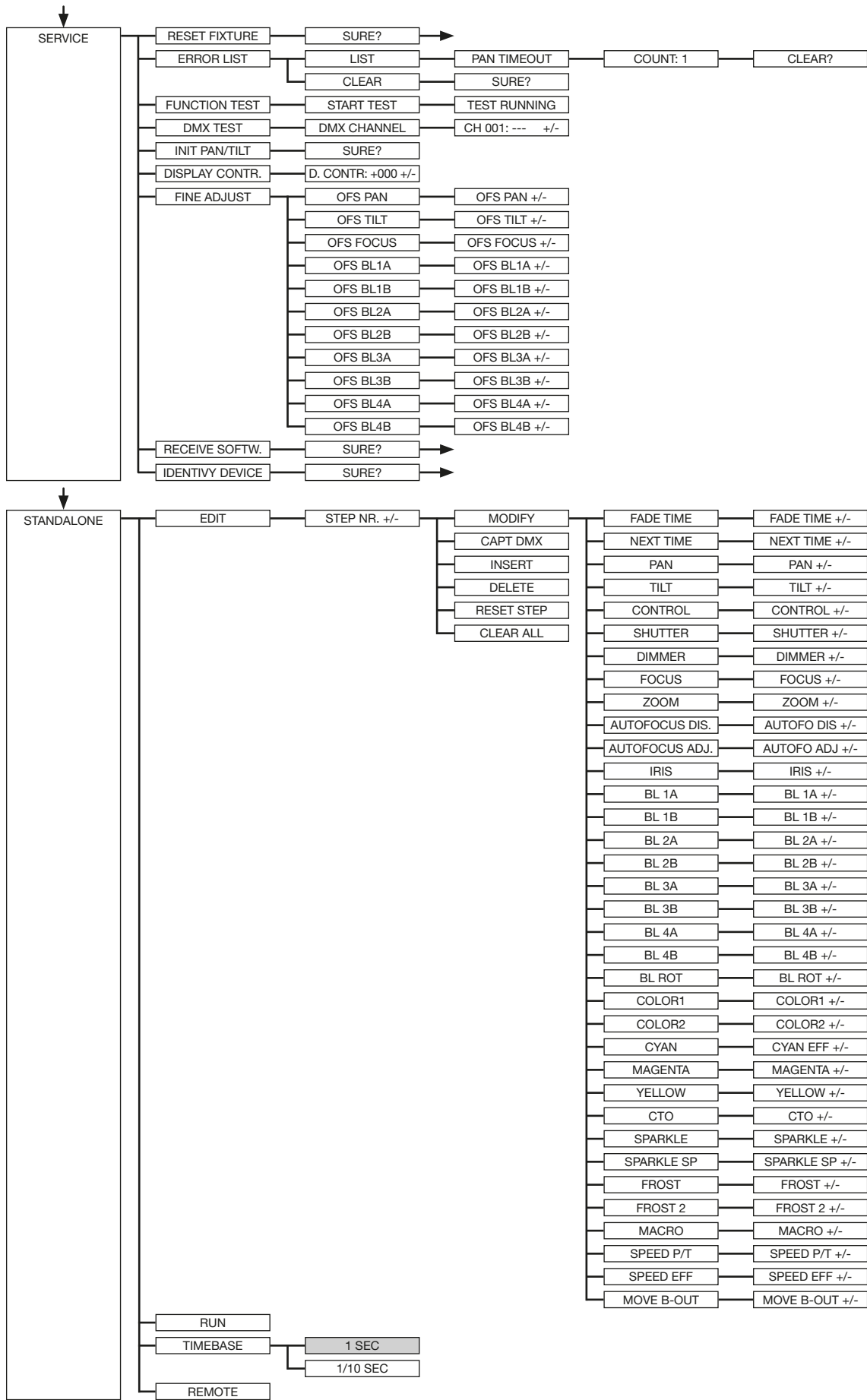

# P 18 WASH MK2

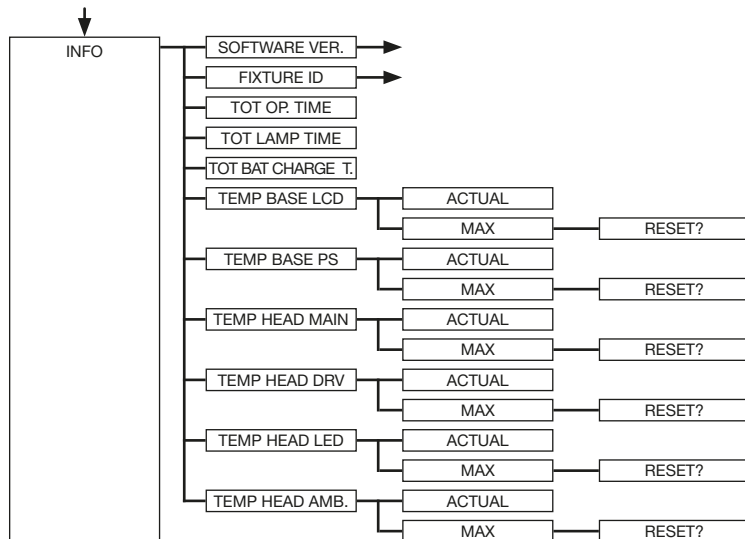

## 6.0 Control options

### 6.1 DMX

#### 6.1.1 Operating modes

The P18 Wash MK2 offers 2 different channel modes. Menu PERSONALITY -> DMX MODE you can select your mode. The used mode will be displayed in the main menu.

	Mode 1(M1)	Mode 2 (M2)
Channel 1	Pan	Pan
Channel 2	Pan fine	Pan fine
Channel 3	Tilt	Tilt
Channel 4	Tilt fine	Tilt fine
Channel 5	Control channel	Control channel
Channel 6	Shutter	Shutter
Channel 7	Dimmer	Dimmer
Channel 8	Focus	Fine dimmer
Channel 9	Zoom	Focus
Channel 10	Focus distance	Fine focus
Channel 11	Focus adjust	Zoom
Channel 12	Iris	Fine zoom
Channel 13	Aperture 1a	Focus distance
Channel 14	Aperture 1b	Focus adjust
Channel 15	Aperture 2a	Iris
Channel 16	Aperture 2b	Fine iris
Channel 17	Aperture 3a	Aperture 1a
Channel 18	Aperture 3b	Aperture 1a fine
Channel 19	Aperture 4a	Aperture 1b
Channel 20	Aperture 4b	Aperture 1b fine
Channel 21	Aperture rotation	Aperture 2a
Channel 22	Colour wheel 1	Aperture 2a fine
Channel 23	Colour wheel 2	Aperture 2b
Channel 24	Cyan	Aperture 2b fine
Channel 25	Magenta	Aperture 3a
Channel 26	Yellow	Aperture 3a fine
Channel 27	CTO	Aperture 3b
Channel 28	Sparkle	Aperture 3b fine

Channel 29	Sparkle speed	Aperture 4a
Channel 30	Frost 1	Aperture 4a fine
Channel 31	Frost 2	Aperture 4b
Channel 32	Pan/tilt speed	Aperture 4b fine
Channel 33	Effect speed	Aperture rotation
Channel 34	Blackout Move	Fine aperture rotation
Channel 35		Colour wheel
Channel 36		Colour wheel
Channel 37		Cyan
Channel 38		Fine cyan
Channel 39		Magenta
Channel 40		Fine magenta
Channel 41		Yellow
Channel 42		Fine yellow
Channel 43		CTO
Channel 44		CTO fine
Channel 45		Sparkle
Channel 46		Sparkle speed
Channel 47		Frost 1
Channel 48		Frost 2
Channel 49		Pan/tilt speed
Channel 50		Effect speed
Channel 51		Blackout Move

## 6.1.2 DMX channel assignment Mode 1 and Mode 2





M1	M2	Function	DMX
1	1	<b>Pan (X)</b> movement 546.74°	000-255
2	2	<b>Pan (X)</b> fine (16 Bit)	000-255
3	3	<b>Tilt (Y)</b> movement 281.16°	000-255
4	4	<b>Tilt (Y)</b> fine (16 Bit)	000-255
5	5	<p><b>Control channel</b> To enable uniform dimming manually via faders for all light mixing consoles, 5 different settings for the DMX smoothing are available. If the DMX signal is interrupted or too few packets are sent on some DMX consoles, the response of the Sparx 18/30 can be adjusted with this channel. The Minimum DMX Smoothing setting should work on most popular consoles. The values for DMX smoothing must be permanent. For the other values, such as cooling mode, color temperature, zoom modes, camera mode, reset, the values must be applied for 2 seconds, then the device will be permanently switched (Same setting as in the PERSONALITY menu).</p> <p><b>Setting for minimal DMX smoothing</b> (A dimmed shutter sequence is possible) Dimmer fade out via fader (fast - slow) not used</p> <p><b>Setting for minimum / medium DMX smoothing</b> Dimmer fade out via fader (fast - slow) not used</p> <p><b>Setting for medium DMX smoothing</b> Dimmer fade out via fader (fast - slow) not used</p> <p><b>Setting for medium / maximum DMX smoothing</b> Dimmer fade out via fader (fast - slow)</p> <p><b>BACKLIGHT MODE - Display backlight configuration</b> AUTO - the fixture controls the backlight automatically ON - the backlight is always on OFF - the backlight is always off until a key is pressed</p> <p><b>DISPLAY ORIENTATION - display flip or not</b> STANDARD - the display can be read when the headlamp is on a surface FLIP - the display orientation is rotated by 180 °, hanging readable not used</p> <p><b>MAIN SCREEN MODE - view of the main screen</b> STANDARD - the main screen displays the DMX address, the DMX mode, and when wireless is enabled, the field strength. USER FIXTURE ID - the main screen displays the user definable fixture ID / head-light number not used</p> <p><b>USER FIXTURE ID SET - Scheinwerfernummer setzen</b> SET - the USER ID can be set. The headlamp takes the 16-bit value of Pan for the USER ID not used</p>	<p>000-007 008-031</p> <p>032-039 040-063</p> <p>064-071 072-095</p> <p>096-103</p> <p>104-104 105-105 106-106</p> <p>107-107 108-108 109-109</p> <p>110-110 111-111 112-112</p> <p>113-113 114-127</p>

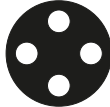

	<p><b>Setting for maximum DMX smoothing</b> Dimmer fade out via fader (fast - slow)</p>	128-135
	<p><b>DIMMER CURVE - selection of dimmer curve</b> LINEAR - linear dimmer curve SQUARE - exponential dimmer curve SQUARE INVERSE - exponential inverse dimmer curve not used</p>	136-136 137-137 138-138 139-139
	<p><b>RGB/CMY CURVE - selection of RGB/CMY curve</b> LINEAR - linear RGB/CMY curve SQUARE INVERSE - Exponential inverse RGB/CMY curve LINEAR MK1 - linear RGB/CMY curve adapted to P18 MK1</p>	140-140 141-141 142-142
	<p><b>FROST CURVE - selection of frost curve</b> LINEAR - linear frost curve SQUARE INVERSE - Exponential inverse frost curve not used</p>	143-143 144-144 145-145
	<p><b>PAN/TILT SPEED - selection of PAN/TILT speed</b> WHISPER SILENT MEDIUM FAST</p>	146-146 147-147 148-148 149-149
	<p><b>EFFECT SPEED - selection of effect speed</b> WHISPER SILENT MEDIUM FAST</p>	150-150 151-151 152-152 153-153
	<p><b>LED FADE OUT MODE - selection of dimming out</b> STANDARD SOFT not used</p>	154-154 155-155 156-159
	<p><b>COOLING MODE - Adjust the fan volume and brightness</b> This takes place with dimmer / shutter set to closed (DMX 000) then after 2 seconds the fixture will switch this option, except the switch "SAFE MODE SWITCH" in the PERSONALITY menu is set to OFF, then the changeover can take place directly without dimmer and shutter having to be closed. THEATRE WHISPER THEATRE SILENT STANDARD BOOST LONGLIFE not used</p>	160-160 161-161 162-162 163-163 164-164 165-207
	<p><b>CAMERA MODE - Setting the LED refresh rate</b> 50Hz 60Hz FLEX - 600Hz High FLEX - 3kHz not used</p>	208-215 216-223 224-227 228-231 232-239
	<p><b>RESET - a basic reset of the fixture is carried out</b> Reset nicht belegt</p>	240-247 248-255

# P 18 WASH MK2

6	6	<b>Shutter</b> Shutter closed Shutter open Open pulsing shutter >20Hz (rapid - slow) Shutter open Fade effect with dimmer (slow - rapid) Shutter open Shutter closed Open pulsing shutter <20Hz (rapid - slow) Shutter open Close pulsing shutter >20Hz (rapid - slow) Shutter closed Shutter fade, 0% (rapid - slow) Shutter open Shutter fade, 100% (rapid - slow) Shutter closed Random shutter 100% (rapid - slow) Shutter open Random shutter 0% (rapid - slow) Shutter closed Random shutter fade, 0% (rapid- slow) Shutter open Random shutter fade, 100% (rapid- slow) Shutter open	000-015 016-095 096-110 111-111 112-125 126-126 127-126 128-142 143-143 144-158 159-159 160-174 175-175 176-190 191-191 192-206 207-207 208-222 223-223 224-238 239-239 240-254 255-255
7	7	<b>Dimmer 0 - 100%</b>	000-255
	8	<b>Fine dimmer (16Bit)</b>	000-255
8	9	<b>Focus 0-100%</b>	000-255
	10	<b>Fine focus (16 Bit)</b>	000-255
9	11	<b>Zoom 0 -100% (near 13° - far 65°)</b>	000-255
	12	<b>Fine zoom (16 Bit)</b>	000-255
10	13	<b>Auto focus distance</b> works from version 1.5 Auto focus off Auto focus 0 m - 25,5 m (0=off, DMX / 10 = distance)	000-001 002-255
11	14	<b>Auto focus adjust</b> (no function, not needed) Auto focus adjust - DMX 128 center	000-255
12	15	<b>Iris 0-100% (open -&gt; closed)</b>	000-255
	16	<b>Fine iris (16Bit)</b>	000-255
13	17	<b>Gobo wheel 1 - rotating gobos</b> Gobo 0  Gobo 1	 000-007  008-015

		Gobo 2		016-023
		Gobo 3		024-031
		Gobo 4		032-039
		Gobo 5		040-047
		Gobo 6		048-127
		Gobo 0 (open)		128-135
		Gobo 1 shake (fast - slow)		136-143
		Gobo 2 shake (fast - slow)		144-151
		Gobo 3 shake (fast - slow)		152-159
		Gobo 4 shake (fast - slow)		160-167
		Gobo 5 shake (fast - slow)		168-175
		Gobo 6 shake (fast - slow)		176-191
		Gobo wheel rotation (fast - slow)		192-223
		Gobo wheel rotation (slow - fast)		224-255
14	18	<b>Gobo positioning/rotation 1</b> Gobo positioning 0° - 540° Gobo rotation, right (rapid - slow) Stop gobo rotation Gobo rotation, left (slow - rapid)		000-191 192-222 223-224 225-255
	19	<b>Fine gobo positioning/rotation 1 (16 Bit)</b>		000-255
15	20	<b>Aperture 1a 0-100%</b>		000-255
	21	<b>Aperture 1a fine (16 Bit)</b>		000-255
16	22	<b>Aperture 1b 0-100%</b>		000-255
	23	<b>Aperture 1b fine (16 Bit)</b>		000-255
17	24	<b>Aperture 2a 0-100%</b>		000-255
	25	<b>Aperture 2a fine (16 Bit)</b>		000-255
18	26	<b>Aperture 2b 0-100%</b>		000-255
	27	<b>Aperture 2b fine (16 Bit)</b>		000-255
19	28	<b>Aperture 3a 0-100%</b>		000-255
	29	<b>Aperture 3a fine (16 Bit)</b>		000-255



	42		<b>Fine yellow</b> (16 Bit)	000-255
27	43		<b>CTO</b> (8 Bit) 0-100% ( <b>CTB</b> model WW (8 Bit) 0-100%)	000-255
	44		<b>Fine CTO</b> (16 Bit) ( <b>Fine CTB</b> model WW (16 Bit))	000-255
28	45		<b>Sparkle - Glitter effect</b> Sparkle effect inactive Sparkle effect intensity (minimum - maximum)	000-000 001-255
29	46		<b>Sparkle speed</b> Faded sparkle effect (slow -> rapid) Switched sparkle effect (slow -> rapid) Repetition of the fading and switching blocks	000-031 032-063 064-255
30	47		<b>Frost 1</b> Frost 0-100%	000-255
31	48		<b>Frost 2</b> Frost 0-100%	000-255
32	49		<b>Pan/tilt speed</b> Real-time motion Delayed motion (rapid - slow)	000-003 004-255
33	50		<b>Effects speed</b> Real-time effects Delayed effects (rapid - slow)	000-003 004-255
34	51		<b>Blackout Move</b> Not assigned Blackout during pan/tilt Blackout during Colour, CMY, Iris, Frost Blackout during Colour, CMY, Iris, Frost, Zoom, Focus Blackout during Colour, CMY, Iris, Frost, Pan/Tilt Blackout during Colour, CMY, Iris, Frost, Zoom, Focus, Pan/Tilt	000-095 096-127 128-159 160-191 192-223 224-255

## 6.1.3 Control channel

Via the control channel different functions of the fixture can be permanently switched. The following functions can be switched via the control channel.

Response of the headlamp when dimming via faders

BACKLIGHT MODE - display backlight

DISPLAY ORIENTATION - display orientation

MAIN SCREEN MODE - main screen view

USER FIXTURE ID SET - set headlight number

DIMMER CURVE - dimmer curve adjustment

RGB / CMY CURVE - adjust the RGB / CMY curve

FROST CURVE - setting the frost curve

PAN / TILT SPEED - pan / tilt speed

EFFECT SPEED - effect speed

LED FADE OUT MODE - type of dimming

COOLING MODE - adjust the fan volume and brightness

CAMERA MODE - sets the LED refresh rate

RESET - a basic reset of the headlight is performed

For details, see DMX Channel functions for the P18 Profile on page 24.

## 6.1.4 Sparkle effect, sparkle speed

Animation effects can be created via this channel in connection with the focus. Depending on the intensity, the projection can be made to shake more or less. This effect can be dimmed or switched.

## 6.1.5 Zoom, auto focus distance, autofocus adjust

Using the two channels autofocus distance and autofocus adjustment can be from Software Ver. 1.5 the focus over the entire zoom range automatically be readjusted.

## 6.2 Artnet

The spotlight can be controlled via Artnet - ArtNET 4. To do this, set the Artnet address via the menu item DMX / NET ADDR -> ARTNET ADDRESS and also select it via the menu item PERSONALITY -> DMX INPUT CONFIG -> NETWORK -> MODE -> ARTNET. In addition, define the IP address of the spotlight via PERSONALITY -> DMX INPUT CONFIG -> NETWORK -> IP ADDRESS.

## 6.3 Streaming ACN

The headlight can be controlled via sACN - Streaming ACN. To do this, set the sACN address via the menu item DMX / NET ADDR -> SACN ADDRESS and also select it via the menu item PERSONALITY -> DMX INPUT CONFIG -> NETWORK -> MODE -> SACN. In addition, define the IP address of the spotlight via PERSONALITY -> DMX INPUT CONFIG -> NETWORK -> IP ADDRESS.

## 6.4 Wireless-DMX

The P18 MK2 Wash is equipped with a Lumen Radio CRMX receiver for wireless DMX. The receiver can process both DMX and RDM. If there is a cable and wireless connection to the P18 MK2 Wash, the cable connection has priority! The received signal can be output via the DMX connection. To do this, set the DMX OUTPUT CONFIG setting to ON in the PERSONALITY menu. After confirming with ENTER, the spotlight will output the entire universe received via wireless DMX.

## 6.5 RDM

The P18 MK2 Wash can communicate via RDM (Remote Device Management) in accordance with ESTA American National Standard E1.20-2006. RDM is a bidirectional communication protocol for use in DMX512 control systems. It is the open standard for the configuration and status monitoring of DMX-512 devices. The RDM protocol enables data packets to be inserted into a DMX-512 data stream without affecting existing non-RDM devices. It enables a console or dedicated RDM controller to send commands to specific devices and receive messages. The P18 can send and receive RDM via DMX and Artnet 4. The spotlight is also designed to send RDM via sACN and receive it via Artnet. The RDM functionality depends on the lighting control desk used, the operating instructions of the respective desk manufacturer must also be observed.

### 6.5.1 RDM-UID

Every P18 MK2 Wash has a factory-set RDM-UID (unique identification number), which makes it addressable and identifiable in RDM systems.

### 6.5.2 RDM-PIDs

The P18 MK2 Wash supports the RDM PIDs (parameter IDs) required by ESTA as well as manufacturer-specific PIDs.

### 6.5.3 Standard RDM parameter IDs

RDM parameter ID	GET	SET	DISCOVERY	Note
RDM identification				
DISC_UNIQUE_BRANCH			✓	is used for fixture identification
DISC_MUTE			✓	is used for fixture identification
DISC_UN_MUTE			✓	is used for fixture identification
RDM status determination				
QUEUED_MESSAGE	✓			
STATUS_MESSAGES	✓			
STATUS_ID_DESCRIPTION	✓			
CLEAR_STATUS_ID		✓		
RDM information				
SUPPORTED_PARAMETERS	✓			
RDM configuration				
DEVICE_MODEL_DESCRIPTION	✓			
MANUFACTURER_LABEL	✓			
FACTORY_DEFAULTS		✓		
SOFTWARE_VERSION_LABEL	✓			
DMX_PERSONALITY		✓		
DMX_PERSONALITY_DESCRIPTION	✓			
DMX_START_ADDRESS		✓		
SENSOR_DEFINITION	✓			
DEVICE_HOURS	✓			
LAMP_HOURS	✓			
IDENTIFY_DEVICE		✓		
RESET_DEVICE		✓		
PERFORM_SELFTEST		✓		
SELFTEST_DESCRIPTION	✓			

## 6.5.4 Manufacturer specific RDM parameter IDs

RDM parameter ID	GET	SET	DISCO- VERY	Note
RDM configuration				
Battery Charge Hours	✓			
Error Number	✓			
Error	✓			
Select Next Error		✓		
Remove Error		✓		
Remove New Error Flag		✓		
User Defaults		✓		
User Fixture ID		✓		
Fixture Lock On/Off	✓	✓		
Dimmer Curve	✓	✓		
RGB Curve	✓	✓		
Frost Curve	✓	✓		
Camera Mode	✓	✓		
Cooling Mode	✓	✓		
Pan Tilt Speed	✓	✓		
Effect Speed	✓	✓		
Backlight Mode	✓	✓		
Disp Orientation	✓	✓		
Main Screen Mode	✓	✓		
Safe Mode Switch	✓	✓		
LED Fade Out Mode	✓	✓		

## 6.5.5 RDM sensor IDs

RDM sensor ID	GET	SET	DISCO- VERY	Note
RDM sensors				
Temp Sens Base LCD	✓	✓		
Temp Sens Base PS	✓	✓		
Temp Sens Head PCB	✓	✓		
Temp Sens Head Drv	✓	✓		
Temp Sens Head LED	✓	✓		
Temp Sens Head Air	✓	✓		









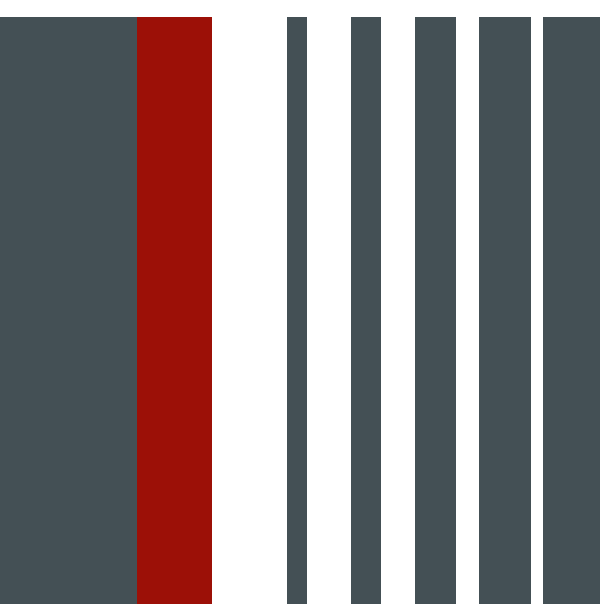

JB-Lighting Lichanlagentechnik GmbH  
Sallersteig 15  
89134 Blaustein  
Tel. +49 7304 9617-0  
Fax. +49 7304 9617-99  
info@jb-lighting.de  
www.jb-lighting.de

**JB LIGHTING**