

2005-09-30

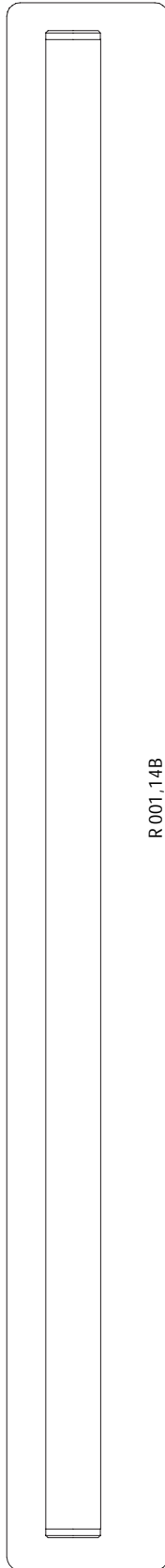

R 001,14B

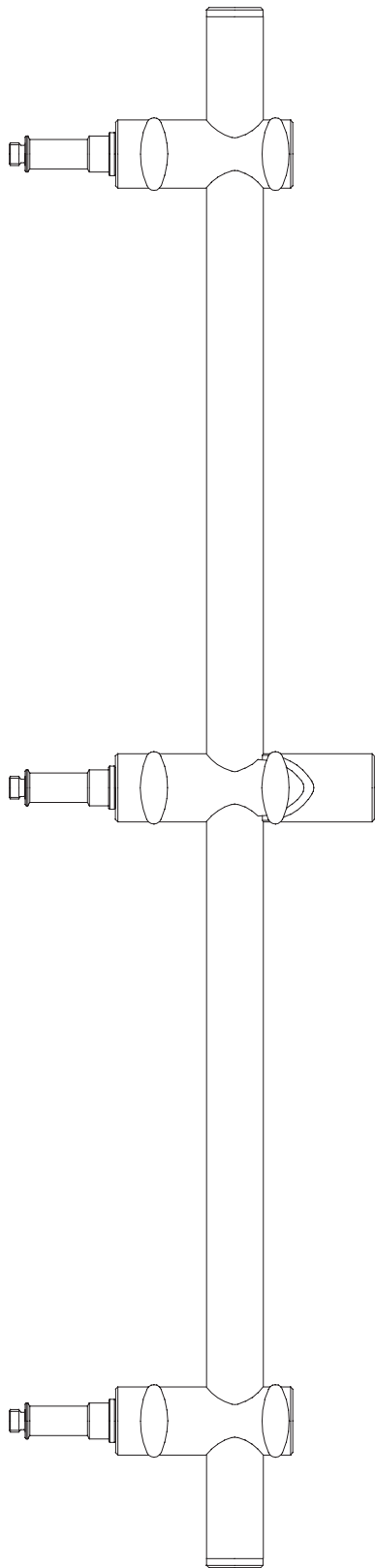
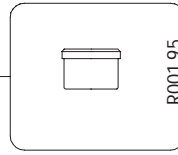

R001,95

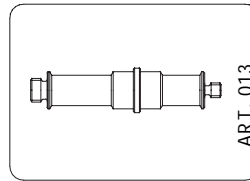

ART, 013

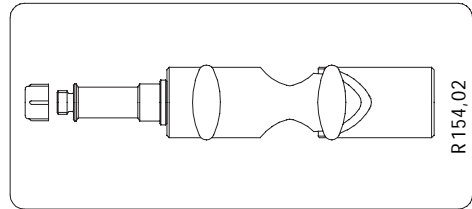

R 154,02

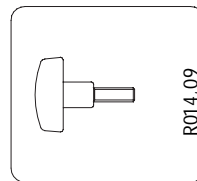

R014,09

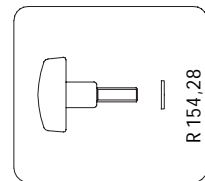

R 154,28

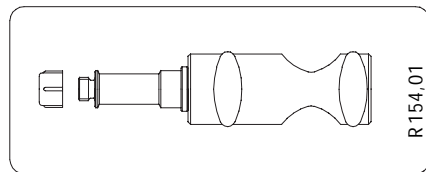

R 154,01