



 **Strand**

LEKO LED PROFILE

FULL COLOR

USER MANUAL

1 DESCRIPTION

FEATURES

- High output midsize LED theatrical luminaires
- High CRI RGBALC Color System with SmartColor Control
- Tunable white with >94 CRI
- Independent color mixing and temperature controls
- Quiet operation with variable fan control
- Adjustable frequency to exceed camera frame rates

Download the product datasheet from the Strand website at www.strandlighting.com for the full technical specifications.

COMPONENTS

The document provides installation and operation instructions for the following products:

- Strand Leko LED Profile Full Color

Read all instructions before installing or using this product. Retain this manual for future reference. Additional product information and descriptions may be found on the product specification sheet.

INCLUDED ITEMS

Each Strand Leko LED Profile luminaire includes the following items:

- Strand Leko LED Profile Full Color
- Quick Start Guide

2 INSTALLATION

MOUNTING

The unit should be mounted via its screw holes on the bracket. Always ensure that the unit is firmly fixed to avoid vibration and slipping while operating. Always ensure that the structure to which you are attaching the unit is secure and is able to support a weight of 10 times of the unit's weight. Always use a safety cable that can hold up to 12 times the weight of the unit when installing the fixture.

The luminaire must be mounted by professionals.

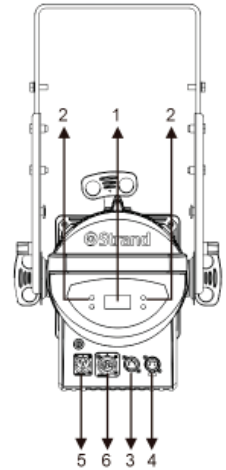

SET UP

CONTROL PANEL

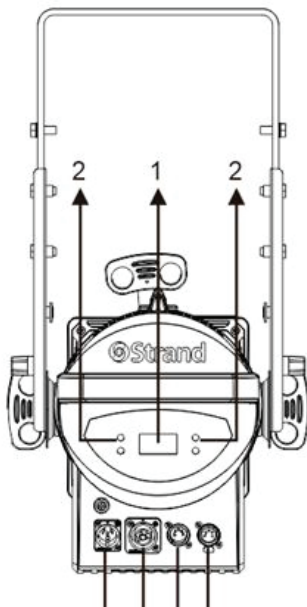

- ① LCD display - shows the menu and selected functions
- ② Buttons:
MENU - To select the programming functions DOWN - To go backward in the selected functions UP - To go forward in the selected functions ENTER - To confirm the selected functions
- ③ DMX IN - 5-pin XLR cable to link DMX console DMX
- ④ OUT - 5-pin XLR cable to link to the next unit DMX In -
- ⑤ connects to power supply
- ⑥ Power Out - connects to next fixture

MAIN FUNCTIONS

To select any functions, press the MENU button until the required one is shown on the display. Select the function by the ENTER button and the display will blink. Use the DOWN and UP button to change the mode. Once the required mode has been selected, press the ENTER button to setup or it will automatically return to the main functions without any change after idling one minute. Back to the functions without any change press the MENU button. The main functions are shown in [TABLE 1](#).

TABLE 1. MENU FUNCTIONS

LEVEL 1	LEVEL 2	LEVEL 3	LEVEL 4	LEVEL 5	LEVEL 6	DEFAULT	
Address	001-512	(Default 001)					
Configure	LED	LED Hours	XXXXXX h				
		Reset LED Hour	Are you sure?				
		Dimming Curve	Square Curve				(Default)
			S Curve				
			Linear Curve				
		Tungsten Fade	On				
			Off				(Default)
		Dim Snap	On (Fast)				
			Off (Slow)				(Default)
		LED Frequency	1200Hz				(Default)
			2500Hz				
			5000Hz				
			10000Hz				
			20000Hz				
		White Balance	25000Hz				
			Red		125 - 255		Default 255
			Green		125 - 255		Default 255
			Blue		125 - 255		Default 255
			Amber		125 - 255		Default 255
			Lime		125 - 255		Default 255
			Cyan		125 - 255		Default 255
		Reset		YES/NO			
		Color Cal	On				
Off					(Default)		
Disp Timeout	30 Sec				(Default)		
	5 Min						
	10 Min						
	On						
Select Signal	DMX Only						
	Art-Net						
	SACN						
Set Artnet/ SACN	Set Universe	000-255			(Default 000)		
	Ethernet IP	XXX. XXX. XXX. XXX					
	Ether Mask IP	XXX. XXX. XXX. XXX					

TABLE 1. MENU FUNCTIONS

LEVEL 1	LEVEL 2	LEVEL 3	LEVEL 4	LEVEL 5	LEVEL 6	DEFAULT	
DMX	Address	001-512					
	DMX Mode	SSCC				(Default)	
		SQCC					
		SOCC					
	Pixel Group	Group 1				(Default)	
		Group 3					
		Group 12					
	Cell Direction	Normal				(Default)	
		Flipped					
	Data	Ch 1 - Intensity XXX (Value)					
Ch 2 - Intensity Fine XXX (Value)							
.....All functions							
Fixture	Serial Number	Serial Number electronic format					
	Status	(No Errors... or displays a list of errors)					
	Reboot Fixture	Are you sure?					
	Version	VXXX		MM/D/YY	HH:MM		
	Fixture Hours	XXXXXX h					
	Crossload (Software)	Send					
	Service	Diagnostics	Board Check				
Sensor Check							
Manual Control	Red	0 - 255			(Default 0)		
	Green	0 - 255			(Default 0)		
	Blue	0 - 255			(Default 0)		
	Amber	0 - 255			(Default 0)		
	Lime	0 - 255			(Default 0)		
	Cyan	0 - 255			(Default 0)		
Color Preset	Preset Run	Select preset		1 to 20			
		Intensity		0 - 255			
	Edit Programs				Intensity*	0 - 255	
					Red	0 - 255	
					Green	0 - 255	
					Blue	0 - 255	
					Amber	0 - 255	
					Lime	0 - 255	
					Cyan	0 - 255	
					Store	YES/NO	
			Clear	YES/NO			

ADDRESS MENU

Address — DMX address setting. To select DMX Address, press the ENTER button to confirm. Use the UP/DOWN button to adjust the address from 001 to 512, press the ENTER button to store. Press the MENU button back to the last menu or let the unit idle one minute to exit menu mode.

CONFIGURE MENU

To select Configure, press the ENTER button to confirm, use the UP/DOWN button to select LED, Color Cal, Disp Timeout, Select Signal and Set Artnet / SACN.

LED

To select LED, press the ENTER button to confirm. Use the UP/DOWN button to select LED Hours, Reset LED Hour, Dimming Curve, Tungsten Fade, Dim Snap, LED Frequency and White Balance. Press the ENTER button to store. Press the MENU button back to the last menu or let the unit idle one minute to exit menu mode.

LED Hours — Select LED Hours, press the ENTER button to confirm, LED Hours will show on the display, press the MENU button back to exit.

Reset LED Hours — Select Reset LED Hours, press the ENTER button to confirm, “Are you sure” will show on the display, press the MENU button back to exit.

Dimming Curve — To select Dimming Curve, press the ENTER button to confirm. Use the UP/DOWN button to select Square Law Curve, S Law Curve or Linear Law Curve, press the ENTER button to store. Press the MENU button back to the last menu or let the unit idle one minute to exit menu mode.

Tungsten Fade — Select Tungsten Fade, press the ENTER button to confirm, Use the UP/DOWN button to select ON or OFF, press the MENU button back to exit.

Dim Snap — Select Dim Snap, press the ENTER button to confirm, Use the UP/DOWN button to select ON or OFF, press the MENU button back to exit.

LED Frequency — To select LED Frequency, press the ENTER button to confirm. Use the UP/DOWN button to select 1200Hz, 2500Hz, 5000Hz, 10000Hz, 20000Hz, 25000Hz, press the ENTER button to store. Press the MENU button back to the last menu or let the unit idle one minute to exit menu mode.

White Balance — To select White Balance, press the ENTER button to confirm. Use the UP/DOWN button to select Red, Green, Blue, Amber, Lime, Cyan and RESET, press the ENTER button to store. Press the MENU button back to the last menu or let the unit idle one minute to exit menu mode.

Color Cal

To select Color Cal, press the ENTER button to confirm. Use the UP/DOWN button to select ON or OFF, press the MENU button back to exit.

Disp Timeout

To select Disp Timeout, press the ENTER button to confirm. Use the UP/DOWN button to select 30 Sec, 5min, 10 min or ON, press the MENU button back to exit.

Select Signal

To select Select Signal, press the ENTER button to confirm. Use the UP/DOWN button to select DMX Only, Artnet or SACN, press the MENU button back to exit.

DMX MENU

To select DMX, press the ENTER button to confirm, use the UP/DOWN button to select Address, DMX Mode, Pixel Group, Cell Direction or Data.

Address — To select Address, press the ENTER button to confirm. Use the UP/DOWN button to select from 001 to 512. press the ENTER button to store. Press the MENU button back to the last menu or let the unit idle one minute to exit menu mode.

DMX Mode — To select DMX Mode, press the ENTER button to confirm. Use the UP/DOWN button to select SSCC, SQCC or SOCC, press the ENTER button to store. Press the MENU button back to the last menu or let the unit idle one minute to exit menu mode.

Pixel Group — To select Pixel Group, press the ENTER button to confirm. Use the UP/DOWN button to select Group 1 or Group 4, press the ENTER button to store. Press the MENU button back to the last menu or let the unit idle one minute to exit menu mode.

Cell Direction — To select Cell Direction, press the ENTER button to confirm. Use the UP/DOWN button to select Normal or Flipped, press the ENTER button to store. Press the MENU button back to the last menu or let the

unit idle one minute to exit menu mode.

Data — To select Data, press the ENTER button to confirm. Use the UP/DOWN button to select Ch1 – Intensity xxx(value), Ch2 – Intensity Fine xxx(Value), All functions, press the ENTER button to store. Press the MENU button back to the last menu or let the unit idle one minute to exit menu mode.

FIXTURE MENU

To select Fixture, press the ENTER button to confirm, use the UP/DOWN button to select Status, Reboot fixture, Version, Fixture Hours, Crossload (Software) , Service.

Status

Select Status, press the ENTER button to confirm, Status will show on the display, press the MENU button back to exit.

Reboot Fixture

Select Reboot Fixture, press the ENTER button to confirm, Are you sure? will show on the display, press the ENTER button to store. Press the MENU button back to the last menu or let the unit idle one minute to exit menu mode.

Version

Select Version, press the ENTER button to confirm, Version will show on the display, press the MENU button back to exit.

Fixture Hours

Select Fixture Hours, press the ENTER button to confirm, Fixture Hours will show on the display, press the MENU button back to exit.

Crossload (Software)

Select Crossload (Software), press the ENTER button to confirm, Send will show on the display, press the ENTER button to store. Press the MENU button back to the last menu or let the unit idle one minute to exit menu mode.

NOTE: Incoming DMX must be removed from the fixture or software crossload will not be activated.

Service

To select Service, press the ENTER button to confirm. Diagnostics will show, press the ENTER button to store. Press the MENU button back to the last menu or let the unit idle one minute to exit menu mode.

Diagnostics — To select Diagnostics, press the ENTER button to confirm. Use the UP/DOWN button to select Fan Check, Board Check ,Sensor Check, press the ENTER button to store. Press the MENU button back to the last menu or let the unit idle one minute to exit menu mode.

MANUAL CONTROL MENU

Enter menu mode, select Manual Control, press the ENTER button to confirm, use the UP/DOWN button to select Red, Green, Blue, Amber, Lime and Cyan. Use the UP/DOWN button to adjust the value from 0 to 255, press the ENTER button to store. Press the MENU button back to the last menu or let the unit idle one minute to exit menu mode.

COLOR PRESET MENU

Preset Run

Enter Color Preset mode, select Preset Run, press the ENTER button to confirm, use the UP/DOWN button to select “Select Preset” or Intensity.

Edit Programs

Enter menu mode, select Edit Programs, press the ENTER button to confirm, MODE will show up, use the UP/DOWN button to select Intensity, Red, Green, Blue, Amber, Lime, Cyan, Store or Clear. Use the UP/DOWN button to adjust the value from 0 to 100%, press the ENTER button to store. Press the MENU button back to the last menu or let the unit idle one minute to exit.

3 DMX MAPPING

The fixture can be operated by DMX controller. The following tables assumes a DMX start address of 1. When a different starting address is used, this address becomes channel 1 function and other functions follow in sequence.

TABLE 2. SSCC MODE

DMX CHANNEL	PARAMETER	DEFAULTS	RANGE DMX	DESCRIPTION
1	Intensity (High)	0	0 - 65535	16bit Intensity (Dimmer) Control
2	Intensity (Low)			0 - 100% Output
3	Strobe	0	0 - 255	Strobe S>>>>F
			0 - 9	No Strobe Function - Shutter open
			10 - 99	Strobe S>>>>F
			100 - 109	No Strobe Function - Shutter open
			110 - 179	Lighting Strobe S>>>>F
			180 - 189	No Strobe Function - Shutter open
			190 - 255	Random Strobe S>>>>F
4	Color Preset	0	0 - 255	Calibrated color presets 01 to 33
				User definable color preset 01 to 20
			0 - 10	Channel OFF Color Mixing take priority
			11 - 14	Moroccan Pink
			15 - 18	Pink
			19 - 22	Flesh Pink
			23 - 26	Bright Rose
			27 - 30	Follies Pink
			31 - 34	Fuchsia Pink
			35 - 38	Surprise Pink
			39 - 42	Congo Blue
			43 - 46	Blue
			47 - 50	Virgin Blue
			51 - 54	Midnight Maya
			55 - 58	Double C.T Blue
			59 - 62	Slate Blue
			63 - 66	Regal Blue
			67 - 70	Full C.T Blue
			71 - 74	Steel Blue
			75 - 78	Lighter Blue
			79 - 82	Cyan
			83 - 86	Marine Blue
			87 - 90	Soft Green
			91 - 94	Moss Green
			95 - 98	Green
			99 - 102	Fem Green
			103 - 106	JAS Green
			107 - 110	Pale Green
			111 - 114	Spring Yellow
			115 - 118	Yellow

TABLE 2. SSCC MODE

DMX CHANNEL	PARAMETER	DEFAULTS	RANGE DMX	DESCRIPTION
			119 - 122	Deep Amber
			123 - 126	Chrome Orange
			127 - 130	Orange
			131 - 134	Magenta
			135 - 138	Flame Red
			139 - 142	Purple
			143 - 146	User Preset 1
			147 - 150	User Preset 2
			151 - 154	User Preset 3
			155 - 158	User Preset 4
			159 - 162	User Preset 5
			163 - 166	User Preset 6
			167 - 170	User Preset 7
			171 - 174	User Preset 8
			175 - 178	User Preset 9
			179 - 182	User Preset 10
			183 - 186	User Preset 11
			187 - 190	User Preset 12
			191 - 194	User Preset 13
			195 - 198	User Preset 14
			199 - 202	User Preset 15
			203 - 206	User Preset 16
			207 - 210	User Preset 17
			211 - 214	User Preset 18
			215 - 218	User Preset 19
			219 - 222	User Preset 20
			223 - 255	Channel OFF Color Mixing take priority
5	Fan Control	0	0 - 255	Dynamically control fan speed vs LED Output operation. Control
				values as follows . . .
			0-4	Automatic fan/output adjustment (Default)
			05 - 255	Linear control of fan speed and LED max output*
				DMX 5 =Highest Constant Fan Speed
				DMX 255 = Lowest Constant Fan Speed
				* Standard mode only
6	Control Chanel	0	0 - 255	Control Channel used for full fixture settings, lamp controls, and miscellaneous modes.
				Set discrete value of desired effect, wait >3 seconds, then set value to 0 (Idle).
				**Function does not require 3 Second rule to active, setting output
				to value will automatically activate function
			0 - 5	Idle (Default)
			6 - 10	Full Luminaire ReCal -
				Also Used to Wake fixture up from shutdown
			11 - 15	Fixture Shutdown
			16 - 20	Reserved Values
			21 - 25	Display - Menu ON

TABLE 2. SSCC MODE

DMX CHANNEL	PARAMETER	DEFAULTS	RANGE DMX	DESCRIPTION
			26 - 30	Display - Menu OFF
			31 - 35	Tungsten Dimming On**
			36 - 40	Tungsten Dimming Off (Default)**
			41 - 45	Dimming Curve Linear**
			46 - 50	Dimming Curve S-Curve**
			51 - 55	Dimming Curve Square Law (Default)**
			56 - 60	Reserved
			61 - 65	Dimmer Snap On**
			66 - 70	Dimmer Snap Off (Default)**
			71 - 75	Reserved Values
			76 - 80	Reserved Values
			81 - 85	Reserved Values
			86 - 90	Reserved Values
			91 - 95	Color Calibration on
			96 - 100	Color Calibration off (Default)
			101 - 105	Reserved Values
			106 - 110	Reserved Values
			111 - 115	Standard Mode - (Default)
			116 - 120	Studio Mode - Reduced output with lower fan settings
			121 - 125	Whisper Mode - Reduced output with lower fan settings
			126 - 130	Reserved Values
			131 - 135	Reserved Values
			136 - 140	Fan On (Default)
			141 - 145	Fan Auto
			146 - 150	Reserved Values
			151 - 155	Record User Color Preset**
			156 - 160	Reserved
			161 - 165	Reserved
			166 - 170	Reserved
			171 - 175	Reset fixture to default
			176 - 255	Reserved
7	Cyan (High)	0	0 - 65535	Cyan Color Level Control 0 - 100% Saturation
8	Cyan (Low)			6 Color LED array auto adjust to meet Cyan / mixed color point of full available color spectrum
9	Yellow (High)	0	0 - 65535	Yellow Color Level Control 0 - 100% Saturation
10	Yellow (Low)			6 Color LED array auto adjust to meet Yellow / mixed color point of full available color spectrum
11	Magenta (High)	0	0 - 65535	Magenta Color Level Control 0 - 100% Saturation
12	Magenta (Low)			6 Color LED array auto adjust to meet Magenta / mixed color point of full available color spectrum
13	CTO	75		Variable color temperature control channel
			0 - 250	Channel works independent of color mixing channel and will adjust all mixed color from selected color temperature level. Values stated below are a for guidance only channel should be mapped in such away that channel level runs variable from 0 - 250
			0	1800k
			25	2700K
			50	3000K

TABLE 2. SSCC MODE

DMX CHANNEL	PARAMETER	DEFAULTS	RANGE DMX	DESCRIPTION
			75	3200K (Default)
			100	4000K
			125	4500K
			150	5000K
			175	5600K
			200	6500K
			225	8000K
			250	10000K
			250 - 255	Reserved Hold 10000K
14	Green Shift	100	0 - 255	TV Camera Green Shift adjustment Channel works independent of color mixing channel and will adjust all mixed color from to reduce green color for camera use 0 to -100% Minus Green Levels 100% = to Lee Filter Full minus Green 247
			0-10	NO FUNCTION
			11-29	FULL MINUS GREEN
			30-69	-99% -> -1%
			70-129	NO FUNCTION
			130-189	1% -> 99%
			190-255	FULL PLUS GREEN

TABLE 3. SQCC MODE

DMX CHANNEL	PARAMETER	DEFAULTS	RANGE DMX	DESCRIPTION
1	Intensity (High)	0	0 - 65535	16bit Intensity (Dimmer) Control
2	Intensity (Low)			0 - 100% Output
3	Strobe	0	0 - 255	Strobe S>>>>>F
			0 - 9	No Strobe Function - Shutter open
			10 - 99	Strobe S>>>>>F
			100 - 109	No Strobe Function - Shutter open
			110 - 179	Lighting Strobe S>>>>>F
			180 - 189	No Strobe Function - Shutter open
			190 - 255	Random Strobe S>>>>>F
4	Color Preset	0	0 - 255	Calibrated color presets 01 to 33
				User definable color preset 01 to 20
			0 - 10	Channel OFF Color Mixing take priority
			11 - 14	Moroccan Pink
			15 - 18	Pink
			19 - 22	Flesh Pink
			23 - 26	Bright Rose
			27 - 30	Follies Pink
			31 - 34	Fuchsia Pink
			35 - 38	Surprise Pink
			39 - 42	Congo Blue
			43 - 46	Blue
			47 - 50	Virgin Blue
			51 - 54	Midnight Maya

TABLE 3. SQCC MODE

DMX CHANNEL	PARAMETER	DEFAULTS	RANGE DMX	DESCRIPTION
			55 - 58	Double C.T Blue
			59 - 62	Slate Blue
			63 - 66	Regal Blue
			67 - 70	Full C.T Blue
			71 - 74	Steel Blue
			75 - 78	Lighter Blue
			79 - 82	Cyan
			83 - 86	Marine Blue
			87 - 90	Soft Green
			91 - 94	Moss Green
			95 - 98	Green
			99 - 102	Fem Green
			103 - 106	JAS Green
			107 - 110	Pale Green
			111 - 114	Spring Yellow
			115 - 118	Yellow
			119 - 122	Deep Amber
			123 - 126	Chrome Orange
			127 - 130	Orange
			131 - 134	Magenta
			135 - 138	Flame Red
			139 - 142	Purple
			143 - 146	User Preset 1
			147 - 150	User Preset 2
			151 - 154	User Preset 3
			155 - 158	User Preset 4
			159 - 162	User Preset 5
			163 - 166	User Preset 6
			167 - 170	User Preset 7
			171 - 174	User Preset 8
			175 - 178	User Preset 9
			179 - 182	User Preset 10
			183 - 186	User Preset 11
			187 - 190	User Preset 12
			191 - 194	User Preset 13
			195 - 198	User Preset 14
			199 - 202	User Preset 15
			203 - 206	User Preset 16
			207 - 210	User Preset 17
			211 - 214	User Preset 18
			215 - 218	User Preset 19
			219 - 222	User Preset 20
			223 - 255	Channel OFF Color Mixing take priority

TABLE 4. SOCC MODE

DMX CHANNEL	PARAMETER	DEFAULTS	RANGE DMX	DESCRIPTION
1	Intensity (High)	0	0 - 65535	16bit Intensity (Dimmer) Control
2	Intensity (Low)			0 - 100% Output
3	Strobe	0	0 - 255	Strobe S>>>>>F
			0 - 9	No Strobe Function - Shutter open
			10 - 99	Strobe S>>>>>F
			100 - 109	No Strobe Function - Shutter open
			110 - 179	Lighting Strobe S>>>>>F
			180 - 189	No Strobe Function - Shutter open
			190 - 255	Random Strobe S>>>>>F
4	Color Preset	0	0 - 255	Calibrated color presets 01 to 33
				User definable color preset 01 to 20
			0 - 10	Channel OFF Color Mixing take priority
			11 - 14	Moroccan Pink
			15 - 18	Pink
			19 - 22	Flesh Pink
			23 - 26	Bright Rose
			27 - 30	Follies Pink
			31 - 34	Fuchsia Pink
			35 - 38	Surprise Pink
			39 - 42	Congo Blue
			43 - 46	Blue
			47 - 50	Virgin Blue
			51 - 54	Midnight Maya
			55 - 58	Double C.T Blue
			59 - 62	Slate Blue
			63 - 66	Regal Blue
			67 - 70	Full C.T Blue
			71 - 74	Steel Blue
			75 - 78	Lighter Blue
			79 - 82	Cyan
			83 - 86	Marine Blue
			87 - 90	Soft Green
			91 - 94	Moss Green
			95 - 98	Green
			99 - 102	Fem Green
			103 - 106	JAS Green
			107 - 110	Pale Green
			111 - 114	Spring Yellow
			115 - 118	Yellow
			119 - 122	Deep Amber
			123 - 126	Chrome Orange
			127 - 130	Orange
			131 - 134	Magenta
			135 - 138	Flame Red
			139 - 142	Purple
			143 - 146	User Preset 1
			147 - 150	User Preset 2

TABLE 4. SOCC MODE

DMX CHANNEL	PARAMETER	DEFAULTS	RANGE DMX	DESCRIPTION
			151 - 154	User Preset 3
			155 - 158	User Preset 4
			159 - 162	User Preset 5
			163 - 166	User Preset 6
			167 - 170	User Preset 7
			171 - 174	User Preset 8
			175 - 178	User Preset 9
			179 - 182	User Preset 10
			183 - 186	User Preset 11
			187 - 190	User Preset 12
			191 - 194	User Preset 13
			195 - 198	User Preset 14
			199 - 202	User Preset 15
			203 - 206	User Preset 16
			207 - 210	User Preset 17
			211 - 214	User Preset 18
			215 - 218	User Preset 19
			219 - 222	User Preset 20
			223 - 255	Channel OFF Color Mixing take priority
5	Fan Control	0	0 - 255	Dynamically control fan speed vs LED Output operation. Control
				values as follows . . .
			0-4	Automatic fan/output adjustment (Default)
			05 - 255	Linear control of fan speed and LED max output*
				DMX 5 =Highest Constant Fan Speed
				DMX 255 = Lowest Constant Fan Speed
				* Standard mode only
6	Control Chanel	0	0 - 255	Control Channel used for full fixture settings, lamp controls, and miscellaneous modes.
				Set discrete value of desired effect, wait >3 seconds, then set value to 0 (Idle).
				**Function does not require 3 Second rule to active, setting output
				to value will automatically activate function
			0 - 5	Idle (Default)
			6 - 10	Full Luminaire ReCal -
				Also Used to Wake fixture up from shutdown
			11 - 15	Fixture Shutdown
			16 - 20	Reserved Values
			21 - 25	Display - Menu ON
			26 - 30	Display - Menu OFF
			31 - 35	Tungsten Dimming On**
			36 - 40	Tungsten Dimming Off (Default)**
			41 - 45	Dimming Curve Linear**
			46 - 50	Dimming Curve S-Curve**
			51 - 55	Dimming Curve Square Law (Default)**
			56 - 60	Reserved
			61 - 65	Dimmer Snap On**

TABLE 4. SOCC MODE

DMX CHANNEL	PARAMETER	DEFAULTS	RANGE DMX	DESCRIPTION
			66 - 70	Dimmer Snap Off (Default)**
			71 - 75	Reserved Values
			76 - 80	Reserved Values
			81 - 85	Reserved Values
			86 - 90	Reserved Values
			91 - 95	Color Calibration on
			96 - 100	Color Calibration off (Default)
			101 - 105	Reserved Values
			106 - 110	Reserved Values
			111 - 115	Standard Mode - (Default)
			116 - 120	Studio Mode - Reduced output with lower fan settings
			121 - 125	Whisper Mode - Reduced output with lower fan settings
			126 - 130	Reserved Values
			131 - 135	Reserved Values
			136 - 140	Fan On (Default)
			141 - 145	Fan Auto
			146 - 150	Reserved Values
			151 - 155	Record User Color Preset**
			156 - 160	Reserved
			161 - 165	Reserved
			166 - 170	Reserved
			171 - 175	Reset fixture to default
			176 - 255	Reserved
7	Red (High)	0	0 - 65535	Red Color Level Control 0 - 100% Saturation
8	Red (Low)			
9	Green (High)	0	0 - 65535	Green Color Level Control 0 - 100% Saturation
10	Green (Low)			
11	Blue (High)	0	0 - 65535	Blue Color Level Control 0 - 100% Saturation
12	Blue (Low)			
13	Amber (High)	0	0 - 65535	Amber Color Level Control 0 - 100% Saturation
14	Amber (Low)			
15	Lime (High)	0	0 - 65535	Lime Color Level Control 0 - 100% Saturation
16	Lime (Low)			
17	Cyan (High)	0	0 - 65535	Cyan Color Level Control 0 - 100% Saturation
18	Cyan (Low)			

TABLE 5. COLOR PRESETS

RANGE DMX	COLOR	RANGE DMX	COLOR
0 - 255	Calibrated color presets 01 to 33 User definable color preset 01 to 20	115 - 118	Yellow
0 - 10	Channel OFF Color Mixing take priority	119 - 122	Deep Amber
11 - 14	Moroccan Pink	123 - 126	Chrome Orange
15 - 18	Pink	127 - 130	Orange
19 - 22	Flesh Pink	131 - 134	Magenta
23 - 26	Bright Rose	135 - 138	Flame Red
27 - 30	Follies Pink	139 - 142	Purple
31 - 34	Fuchsia Pink	143 - 146	User Preset 1
35 - 38	Surprise Pink	147 - 150	User Preset 2
39 - 42	Congo Blue	151 - 154	User Preset 3
43 - 46	Blue	155 - 158	User Preset 4
47 - 50	Virgin Blue	159 - 162	User Preset 5
51 - 54	Midnight Maya	163 - 166	User Preset 6
55 - 58	Double C.T Blue	167 - 170	User Preset 7
59 - 62	Slate Blue	171 - 174	User Preset 8
63 - 66	Regal Blue	175 - 178	User Preset 9
67 - 70	Full C.T Blue	179 - 182	User Preset 10
71 - 74	Steel Blue	183 - 186	User Preset 11
75 - 78	Lighter Blue	187 - 190	User Preset 12
79 - 82	Cyan	191 - 194	User Preset 13
83 - 86	Marine Blue	195 - 198	User Preset 14
87 - 90	Soft Green	199 - 202	User Preset 15
91 - 94	Moss Green	203 - 206	User Preset 16
95 - 98	Green	207 - 210	User Preset 17
99 - 102	Fem Green	211 - 214	User Preset 18
103 - 106	JAS Green	215 - 218	User Preset 19
107 - 110	Pale Green	219 - 222	User Preset 20
111 - 114	Spring Yellow	223 - 255	Channel OFF Color Mixing take priority

TABLE 6. GREEN SHIFT

DMX CHANNEL	DEFAULT	RANGE DMX	FUNCTION
Green Shift	100	0 - 255	TV Camera Green Shift adjustment Channel works independently of color mixing channel and will adjust all mixed color from to reduce green color for camera use 0 to -100% Minus Green Levels 100% = to Lee Filter Full minus Green 247
		0-10	NO FUNCTION
		11-29	FULL MINUS GREEN
		30-69	-99% -> -1%
		70-129	NO FUNCTION
		130-189	1% -> 99%
		190-255	FULL PLUS GREEN

TABLE 7. CTO CHANNEL

DMX CHANNEL	DEFAULT	RANGE DMX	FUNCTION
CTO	75	0 - 250	Variable color temperature control channel Channel works independent of color mixing channel and will adjust all mixed color from selected color temperature level. Values stated below are a for guidance only channel should be mapped in such away that channel level runs variable from 0 - 250
		0	1800k
		25	2700K
		50	3000K
		75	3200K (Default)
		100	4000K
		125	4500K
		150	5000K
		175	5600K
		200	6500K
		225	8000K
		250	10000K
		250 - 255	Reserved Hold 10000K

TABLE 8. CONTROL CHANNEL

RANGE DMX	ITEMS	DESCRIPTION	POWER CYCLE RULES	FUNCTION SELECTION VIA UI
0 - 255	Control Channel	Control Channel used for full fixture settings, lamp controls, and miscellaneous modes. Set discrete value of desired effect, wait >3 seconds, then set value to 0 (Idle). **Function does not require 3 Second rule to active, setting output	N/A	N/A
0 - 5	Idle (Default)	Default value used as return point to activate all control functions	N/A	N/A
6 - 10	Full Luminaire ReCal -	Recalibrates all mechanical functions and sensor with in the fixture. Also Used to Wake fixture up from shutdown	N/A	
11 - 15	Fixture Shutdown	Shuts down all fixture output and turns off all fans - fixture is activated by power cycle or ReCal command	If fixture is powered down then up fixture will auto wake and not startup in Shutdown Mode	N/A
16 - 20	Reserved Values		N/A	N/A
21 - 25	Display - Menu ON	Switches UI display backlight on remotely - Display will Time out from on after 5 mins	N/A	N/A
26 - 30	Display - Menu OFF		N/A	N/A
31 - 35	Tungsten Dimming On**	Remote switches Tungsten Dimming color shift on	Holds setting on power cycle	Yes
36 - 40	Tungsten Dimming Off (Default)**	Remote switches Tungsten Dimming color shift off	Holds setting on power cycle	Yes
41 - 45	Dimming Curve Linear**	Selects Linear Dimming Curve, Also Used to Wake fixture up from shutdown	Holds setting on power cycle	Yes
46 - 50	Dimming Curve S-Curve**	Selects S-Law Dimming Curve	Holds setting on power cycle	Yes
51 - 55	Dimming Curve Square Law (Default)**	Selects Square -Law Dimming Curve	Holds setting on power cycle	Yes
56 - 60	Reserved Values			

TABLE 8. CONTROL CHANNEL

RANGE DMX	ITEMS	DESCRIPTION	POWER CYCLE RULES	FUNCTION SELECTION VIA UI
61 - 65	Dimmer Snap On**	Allows for fastest output changes between levels but reduces smoothness dimming LED	Holds setting on power cycle	Yes
66 - 70	Dimmer Snap Off (Default)**	Ensures all fades between output levels remain smooth and flicker free limits fast instant snaps between levels	Holds setting on power cycle	Yes
71 - 75	Reserved Values		N/A	N/A
76 - 80	Reserved Values		N/A	N/A
81 - 85	Reserved Values		N/A	N/A
86 - 90	Reserved Values		N/A	N/A
91 - 95	Color Calibration on	Turns Color calibration on for fixture to fixture color matching on all mixed and preset colors between fixtures limits highest output and max saturation on some colors	Holds setting on power cycle	Yes
96 - 100	Color Calibration off (Default)	Turns Color calibration off fixtures may not match fixture to fixture limits fast instant snaps between levels	Holds setting on power cycle	Yes
101 - 105	Reserved Values		N/A	N/A
106 - 110	Reserved Values	Boost mode - LED output boosted to >120% of standard output fan speeds increased manage heat level of LED (may be limited to only run for XXhrs) NC45 - NC55	N/A	N/A
111 - 115	Standard Mode - Fixture operates at maximum output (Default)	Standard mode - Full LED Output + Full Continuous Fan Spin at top speed (loudest setting) (Fan remain at a constant speed and do not ramp up and down) NC40 *Fans can be switched between On & Auto levels	Holds setting on power cycle	Yes
116 - 120	Studio Mode - Reduced output with lower fan settings	Studio Mode - Fan speed reduced to appropriate amount to reduce dB levels >10% of full speed + LED @ max output approximately 80% of Standard output at appropriate level to ensure LED work at optimum temperature and output efficiency (fan speed remains at a constant speed and do not ramp up or down) NC35	Holds setting on power cycle	Yes
121 - 125	Whisper Mode - Reduced output with lower fan settings	Silent Mode - ideally Fans do not spin + output capped at appropriate level to ensure LED work at optimum temperature and output efficiency (Fan should never switch on in this mode or change speed if they are on) NC15 target level	Holds setting on power cycle	Yes
126 - 130	Reserved Values		N/A	N/A
131 - 135	Reserved Values		N/A	N/A
136 - 140	Fan On (Default)	Fans run at continuous speed for either standard or studio mode in isolation to the LED operating temperature	Holds setting on power cycle	Yes
141 - 145	Fan Auto	Fans will reduce / increase speed on demand based on LED operating temperature for either standard or studio mode	Holds setting on power cycle	Yes
146 - 150	Reserved Values		N/A	N/A
151 - 155	Record User Color Preset**	Takes Current Color mixing values and stores to next available blank User color preset - if preset listing are full preset will not record. User will need to clear preset via fixture UI	N/A	N/A
156 - 160	Reserved		N/A	N/A
161 - 165	Reserved		N/A	N/A

TABLE 8. CONTROL CHANNEL

RANGE DMX	ITEMS	DESCRIPTION	POWER CYCLE RULES	FUNCTION SELECTION VIA UI
166 - 170	Reserved		N/A	N/A
171 - 175	Reset fixture to default	Will reset all parameters to default with the exception of the Mx address, fixture mode and Pixel / Zone selection	N/A	Yes - Will reset DMX address, Mode
176 - 255	Reserved		N/A	N/A

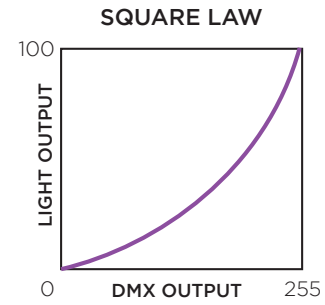
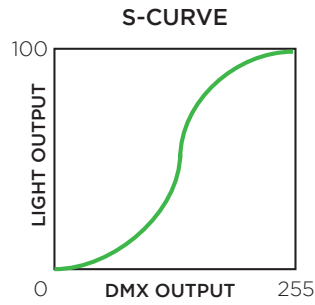
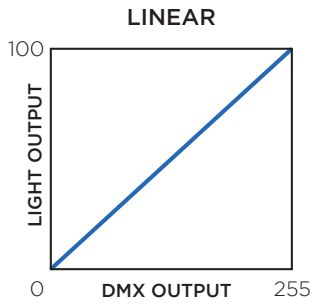

DMX512 CONNECTION

- At last unit, the DMX cable has to be terminated with a terminator. Solder a 120Ω 1/4W resistor between pin 2(DMX-) and pin 3(DMX+) into a 5-pin XLR-plug and plug it in the DMX-output of the last unit.
- Connect the unit together in a `daisy chain` by XLR plug from the output of the unit to the input of the next unit. The cable cannot branched or split to a `Y` cable. DMX 512 is a very high-speed signal. Inadequate or damaged cables, soldered joints or corroded connectors can easily distort the signal and shut down the system.
- The DMX output and input connectors are pass-through to maintain the DMX circuit, when one of the units' power is disconnected.
- Each lighting unit needs to have an address set to receive the data sent by the controller. The address number is between 0-511 (usually 0 & 1 are equal to 1).
- The end of the DMX 512 system should be terminated to reduce signal errors.
- 5 pin XLR: Pin 1: GND, Pin 2: Negative signal (-), Pin 3: Positive signal (+), Pin 4/Pin 5: Not used.

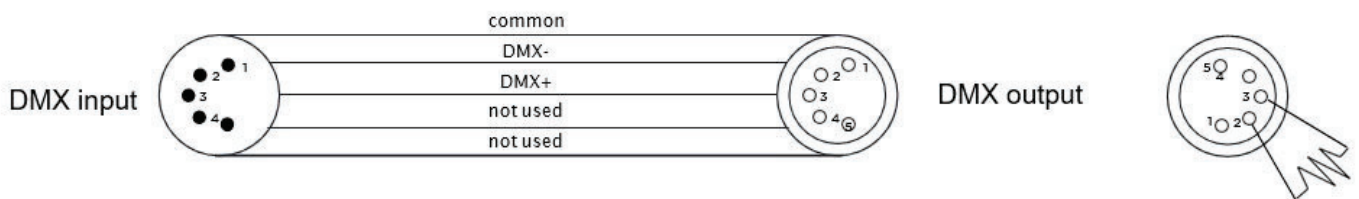
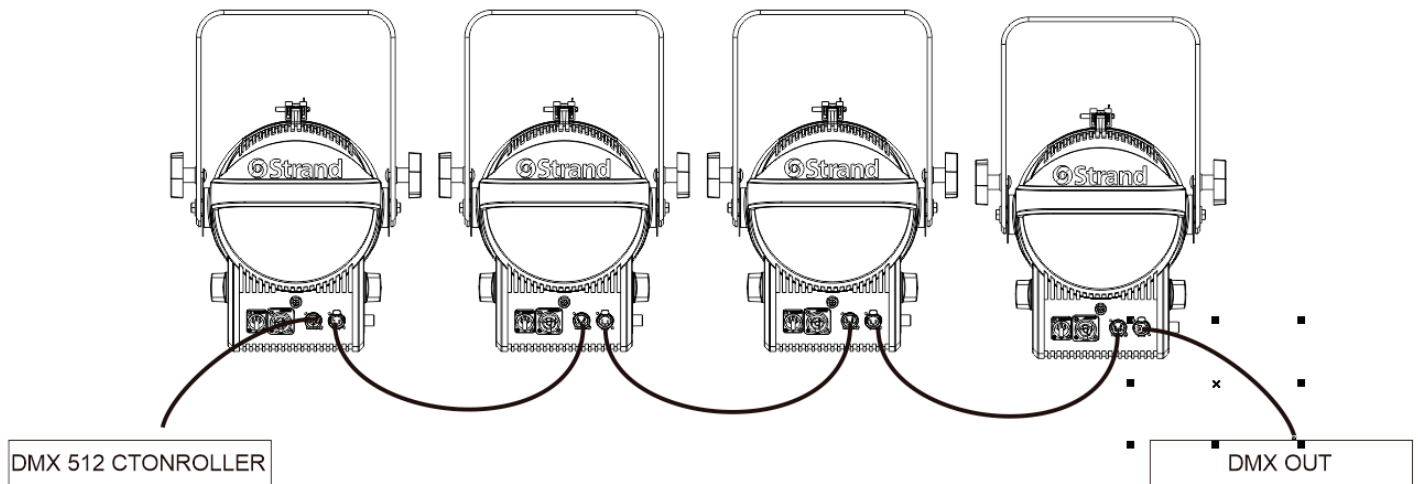

APPENDIX A

CARE AND MAINTENANCE

TROUBLESHOOTING

Following are a few common problems that may occur during operation.

The unit does not work - light and fan do not turn on

- Check the connection of power and main fuse.
- Measure the mains voltage on the main connector.

Not responding to DMX controller

- DMX LED should be on. If not, check DMX connectors, cables to see if link properly.
- If the DMX LED is on and no response to the channel, check the address settings and DMX polarity.
- If you have intermittent DMX signal problems, check the pins on connectors or on PCB of the unit or the previous one.
- Try to use another DMX controller.
- Check if the DMX cables run near or run alongside to high voltage cables that may cause damage or interference to DMX interface circuit.

CLEANING

The cleaning of internal must be carried out periodically to optimize light output. Cleaning frequency depends on the environment in which the fixture operates damp, smoky or particularly dirty surrounding can cause greater accumulation of dirt on the fixture's optics.

- Clean with soft cloth using normal glass cleaning fluid.
- Always dry the parts carefully.
- Clean the external optics at least every 30 days.

ADDENDUM

Fan Speed and Control

All Vari-lite and Strand lighting luminaires will be governed by the same Fan speed v Noise levels v Maximum power output rules as details below. These noises related to these levels will confirm to Noise Criteria levels details of which are contained within the document.

There are 3 control parameters that can be selected separately or in conjunction when permitted to manage Fan speed v Noise levels v Maximum power output.

NOTE: Not all fixture have all modes or functions refer to DMX map and User interface menu tree to see if you product has one of more of these functions.

Item 1 - Fan 'v' Output Preset Modes

These modes are selectable at either / or the fixtures DMX control channel or via the fixture user interface screen. The section of the modes works in conjunction with Items 3 and will also active or deactivate the Item 2.

Boost mode - LED output boosted to >120% of standard output fan speeds increased manage heat level of LED (may be limited to only run for XXhrs). Fixture will not exceed NC45 - NC55 sound levels in this mode

Standard mode - Full LED Output + Fan Spin at top speed (loudest setting). Fixture will not exceed NC40 sound levels in this mode

Studio Mode - Fan speed reduced to appropriate amount to reduce dB levels >10% of full speed + LED @ max output approximately 80% of Standard output at appropriate level to ensure LED work at optimum temperature and output efficiency (fan speed remains at a constant speed and do not ramp up or down) NC35

Whisper mode - Fan speed reduced to appropriate amount to reduce dB levels to >30% of the full speed + LED Max output approximately 60% of Standard output at appropriate level to ensure LED work at optimum temperature and output efficiency (Fan speed remains at a constant speed and do not ramp up or down) NC25

Silent Mode - ideally Fans do not spin + output capped at appropriate level to ensure LED work at optimum temperature and output efficiency (Fan should never switch on in this mode or change speed if they on) NC15 target level.

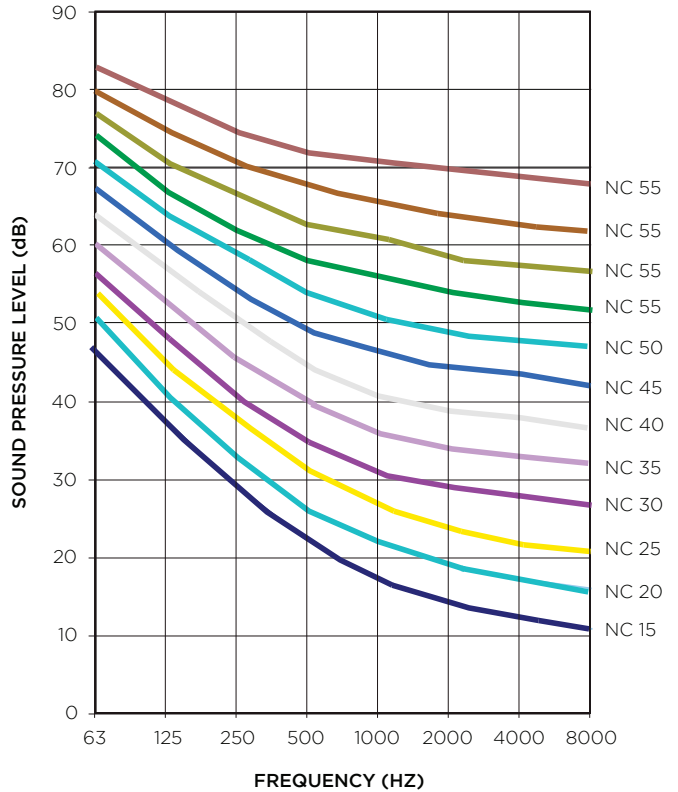

MODE	LED OUTPUT	FAN SPEED	NOISE CRITERION	EQUIVALENT SOUND LEVEL DBA (@3M)
Boost Mode	>100%	Boosted fan speed constant	NC45	50
Standard Mode	Full 100%	Full 100% constant	NC40	45
Studio Mode	80%	Appropriate speed to reduce dB levels >10% of full speed	NC35	40
Whisper Mode	60%	Appropriate speed to reduce dB levels >30% of full speed	NC25	35
Silent Mode	TBC	Fan off	NC15	25

NOISE CRITERION	OCTAVE BAND CENTER FREQUENCY (HZ)							
	63	125	250	500	1000	2000	4000	8000
	SOUND PRESSURE LEVELS (DB)							
NC-15	47	36	29	22	17	14	12	11
NC-20	51	40	33	26	22	19	17	16
NC-25	54	44	37	31	27	24	22	21
NC-30	57	48	41	35	31	29	28	27
NC-35	60	52	45	40	36	34	33	32
NC-40	64	56	50	45	41	39	38	37
NC-45	67	60	54	49	46	44	43	42
NC-50	71	64	58	54	51	49	48	47
NC-55	74	67	62	58	56	54	53	52
NC-60	77	71	67	63	61	59	58	57
NC-65	80	75	71	68	66	64	63	62
NC-70	83	79	75	72	71	70	69	68

HOW TO OBTAIN WARRANTY SERVICE

A copy of the Strand Limited Warranty was included in the shipping package for this Strand product.

To obtain warranty service, please contact customer service at 1-214-647-7880, or entertainment.service@signify.com and request a Return Material Authorization (RMA) for warranty service. You will need to provide the model and serial number of the item being returned, a description of the problem or failure and the name of the registered user or organization. If available, you should have your sales invoice to establish the date of sale as the beginning of the warranty period. Once you obtain the RMA, pack the unit in a secure shipping container or in its original packing box. Be sure to clearly indicate the RMA number on all packing lists, correspondence, and shipping labels. If available, please include a copy of your invoice (as proof of purchase) in the shipping container.

With the RMA number written legibly on or near the shipping address label, return the unit, freight prepaid, to:

Strand
Attention: Warranty Service (RMA# _____)
10911 Petal Street
Dallas, Texas 75238
USA

As stated in the warranty, it is required that the shipment be insured and FOB our service center.

IMPORTANT! When returning products to Strand for repairs (warranty or out-of--warranty) from a country other than the USA, "Strand Lighting LLC", must appear in the address block as the Importer of Record (IOR) on all shipping documentation, Commercial Invoices, etc. This must be done in order to clear customs in a timely manner and prevent returns.

AMERICAS

10911 Petal Street
Dallas, TX 75235
Tel: +1 214-647-7880
Fax: +1 214-647-8039

ASIA

Unit C, 14/F, Roxy Industry Centre
41-49 Kwai Cheong Road
Kwai Chung, Kwai Tsing
Hong Kong
Tel: +852 2796 9786
Fax: +852 2798 6546

Room 1201, Freetown Tower D
E 3rd Ring Rd S, 58
Chaoyang Qu
Beijing Shi, China
Tel: +8610-58674776
Fax: +8610-58674775

B-1-27, Dataran Cascades, No. 13A
Jalan PJU 5/1
Kota Damansara PJU 5
47810 Petaling Jaya
Selangor, Malaysia
Tel: +60 3-7611 7302
Fax: +60 3-7629 4192

EUROPE

Rondweg Zuid 85
Winterswijk 7102 JD
Netherlands
Tel: +31 543-542516
Fax: +31 543-542513

24 Sovereign Park
Coronation Road
Park Royal, London
NW10 7QP
United Kingdom
Tel: +44 020 8965 3209

OCEANIA

14H Vega Place
Rosedale
Auckland 0632
New Zealand
Tel: +64 9-481-0100



©2020 Signify Holding. All rights reserved.

All trademarks are owned by Signify Holding or their respective owners. The information provided herein is subject to change, without notice. Signify does not give any representation or warranty as to the accuracy or completeness of the information included herein and shall not be liable for any action in reliance thereon. The information presented in this document is not intended as any commercial offer and does not form part of any quotation or contract, unless otherwise agreed by Signify. Data subject to change.

LEKO LED PROFILE FULL COLOR USER MANUAL

DOCUMENT NUMBER: 64505-003

VERSION DATE: APRIL 27 2020